

First Three Letters of Last Name:

K	E	Y
---	---	---

TA Name:

--

Exam #2

5.12 Spring 2005
Organic Chemistry I

Printed name _____

Signature _____

ID# _____

Pre-requisite (circle one): 5.112 5.111 3.091

1. Make sure your exam has 9 numbered pages plus a periodic table.
2. Write your initials on each page.
3. Look over the entire exam before you begin to familiarize yourself with its length. Do what you know first, then attempt the harder problems.
4. Read the instructions carefully and budget your time.
5. Show all of your work. Partial credit receives points!

Page	Possible Points	Total
1	8	
2	8	
3	8	
4	16	
5	12	
6	20	
7	18	
8	10	
Total	100	
9	5	
XC	105	

1. (4 pts) Rank the following carbocations in order of stability (1 = most stable).

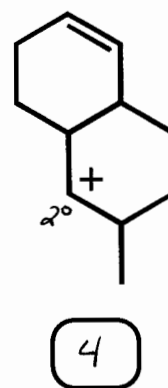
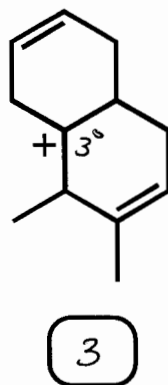
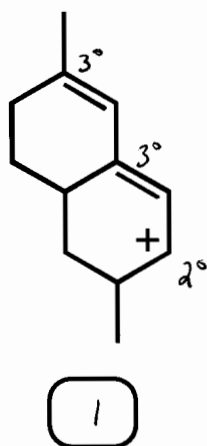
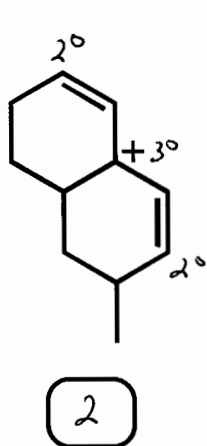

2. (4 pts) Rank the following alkenes according to energy (1 = lowest energy).

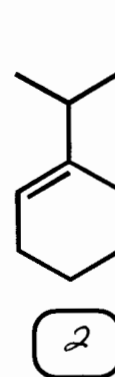
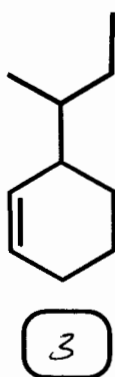
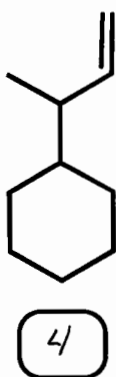
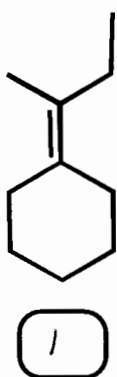

Initials

Points

3. (8 pts) For each of the following reactions:

- label the nucleophile as lone pair (n), pi bond (π), or sigma bond (σ)
- label the electrophile as empty orbital (a), pi bond (π^*), or sigma bond (σ^*)
- use curved arrows to show attack of the nucleophile on the electrophile
- show the product of each reaction

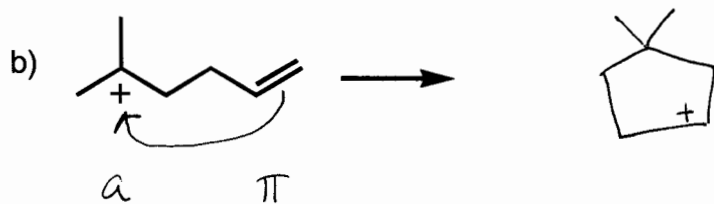
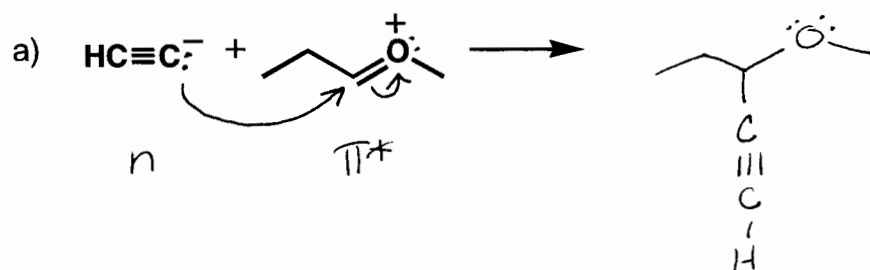

Initials

Points

4. (8 pts) Draw a reaction coordinate diagram for a reaction with the following criteria:

- a) exergonic, 3-step reaction
- b) the first-step is the rate-determining step
- c) the second intermediate is more stable than the first intermediate
- d) the third step of the reaction is faster than the reverse of the second step

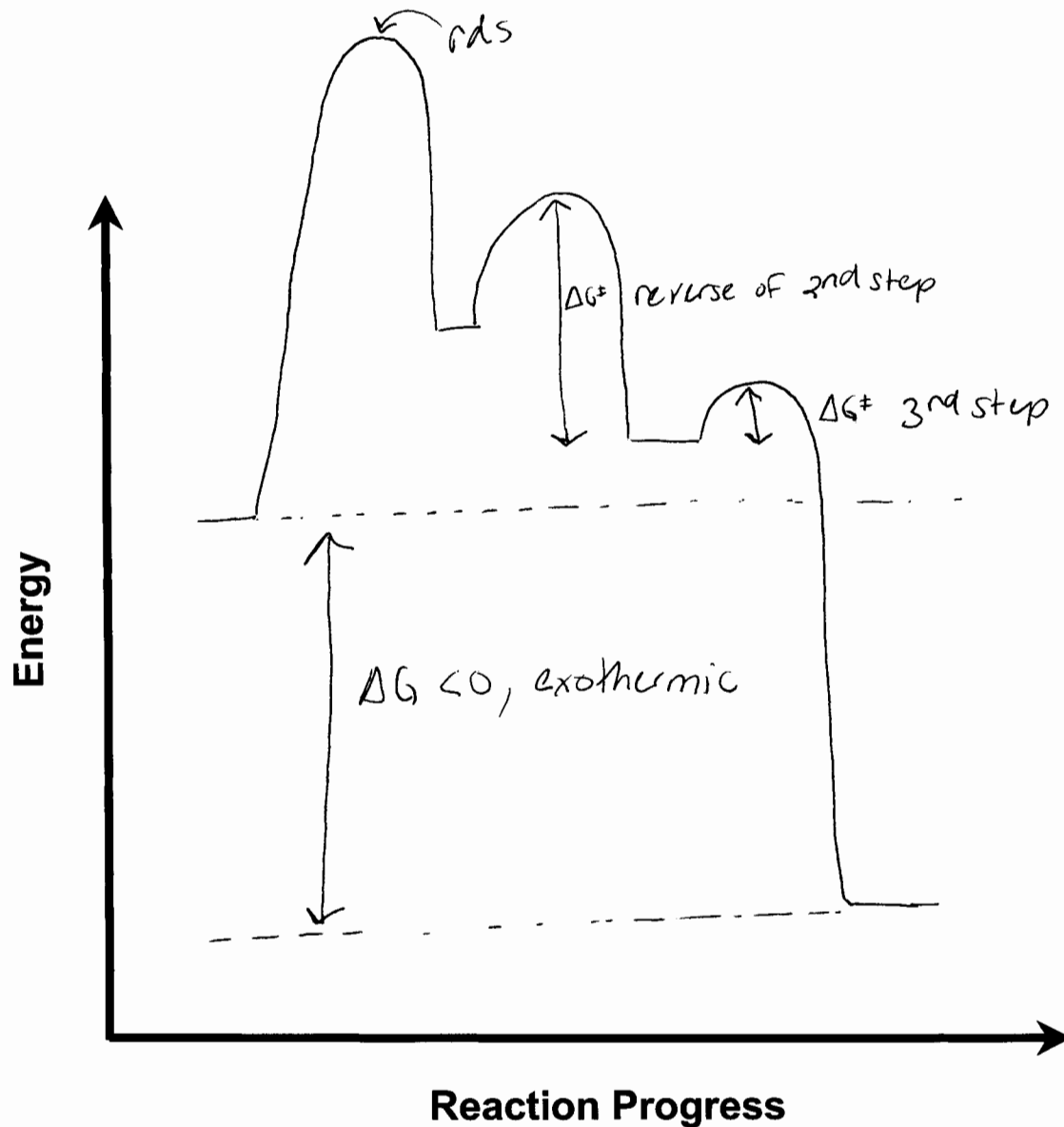

Initials

Points

5. (8 pts) Show the product(s) of each reaction. Ignore stereochemistry.

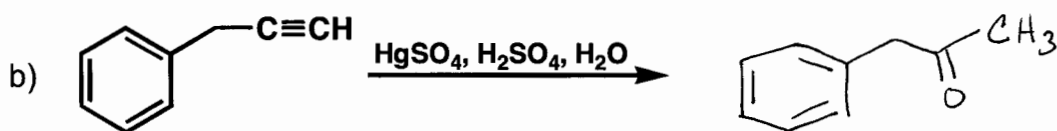
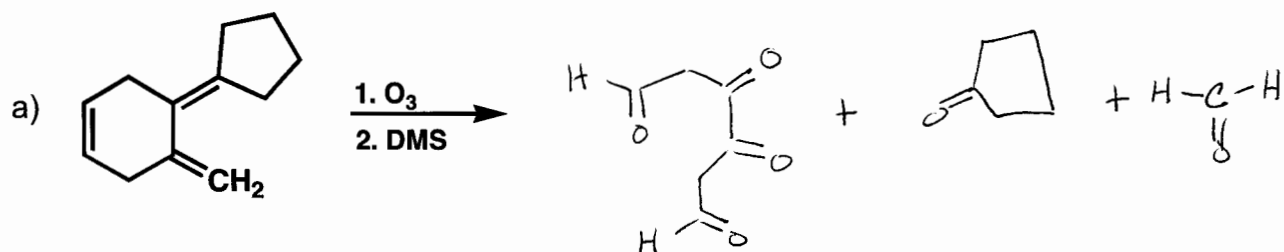

6. (8 pts) Provide products for the following reactions (include all stereoisomers). Indicate if the products are achiral/optically inactive (A) racemic/optically inactive (R), meso/optically inactive (M) or chiral/optically active (C).



R

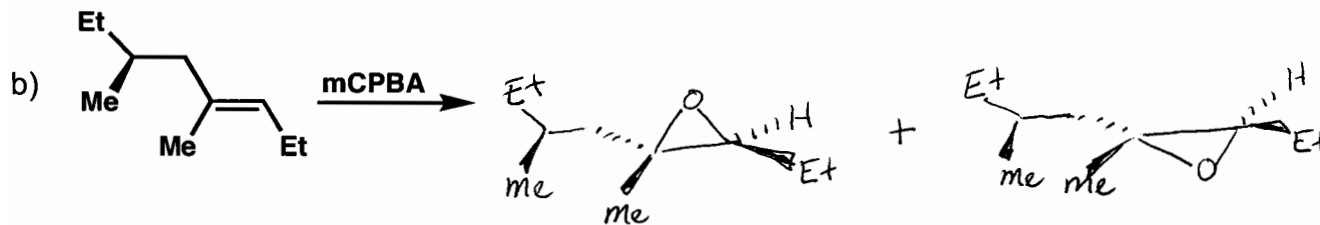

C

Initials

Points

7. (12 pts) Provide the **major** product of each reaction. Include stereochemistry.

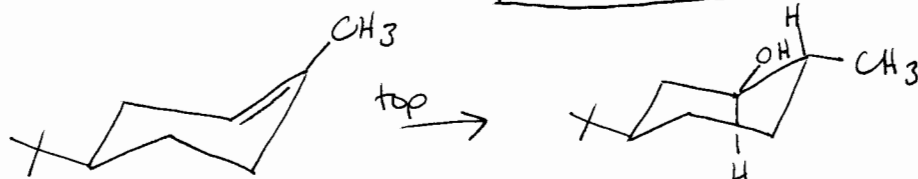
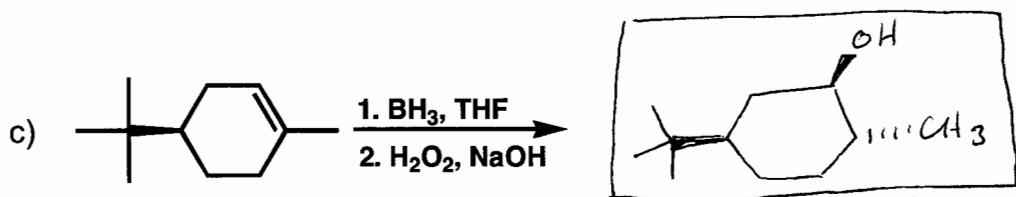
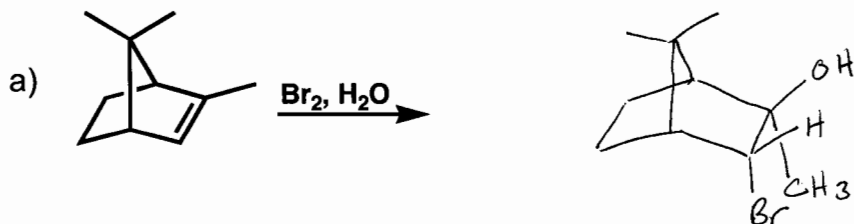

major

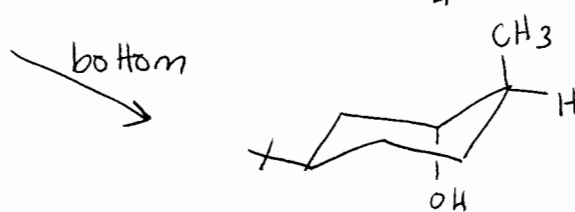

Initials

5

Points

8. (6 pts) Provide an appropriate alkyne starting material, reagents and initial product for the reaction in the boxes provided. The number of carbon atoms in the starting material should equal the number of carbon atoms in the final product.

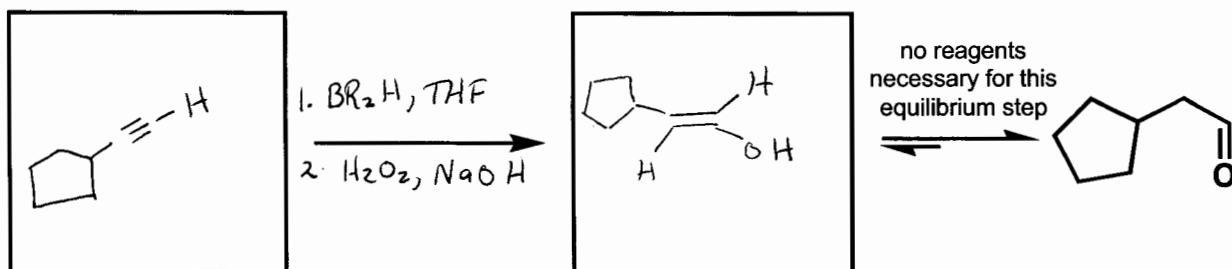

9. (6pts) Provide the missing reagents above each reaction arrow and the final product in the box.

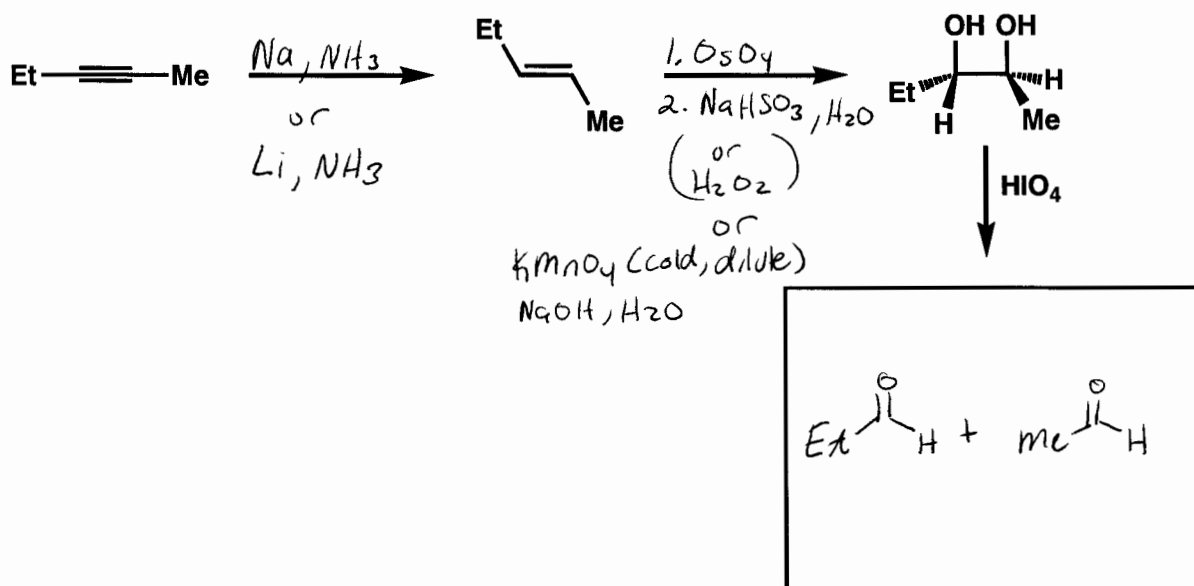

10. (8 pts) Provide an alkyne starting material and all necessary reagents to complete the following 2-step reaction.

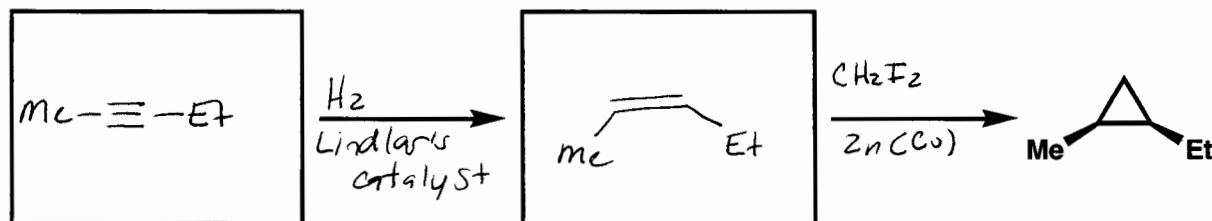

Initials

Points

11. (18 pts) Provide the mechanism and **major** product for each of the following reactions. Ignore stereochemistry.

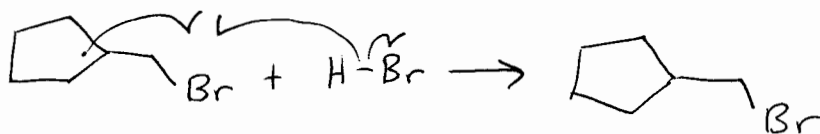
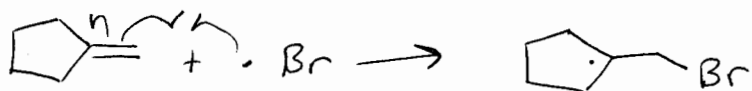
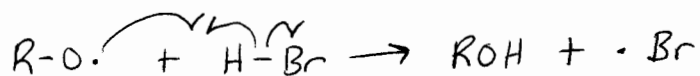
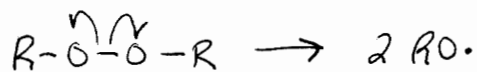
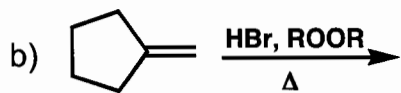
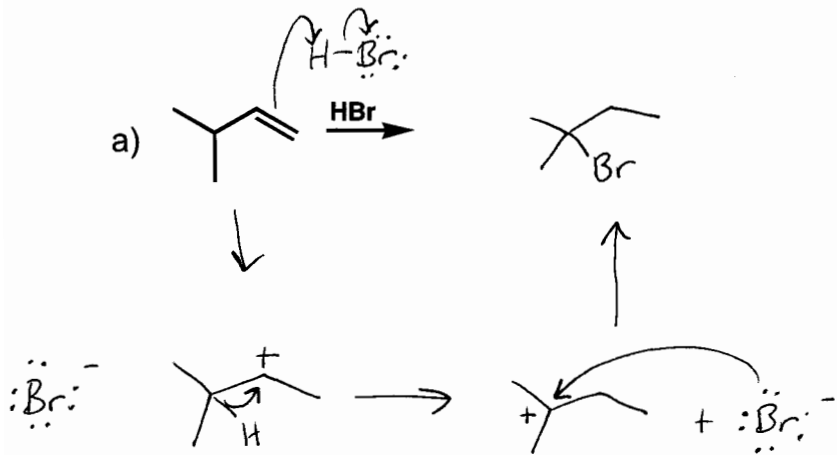

Initials

Points

12. (10 pts) Propose a mechanism for the following reaction. Ignore stereochemistry.

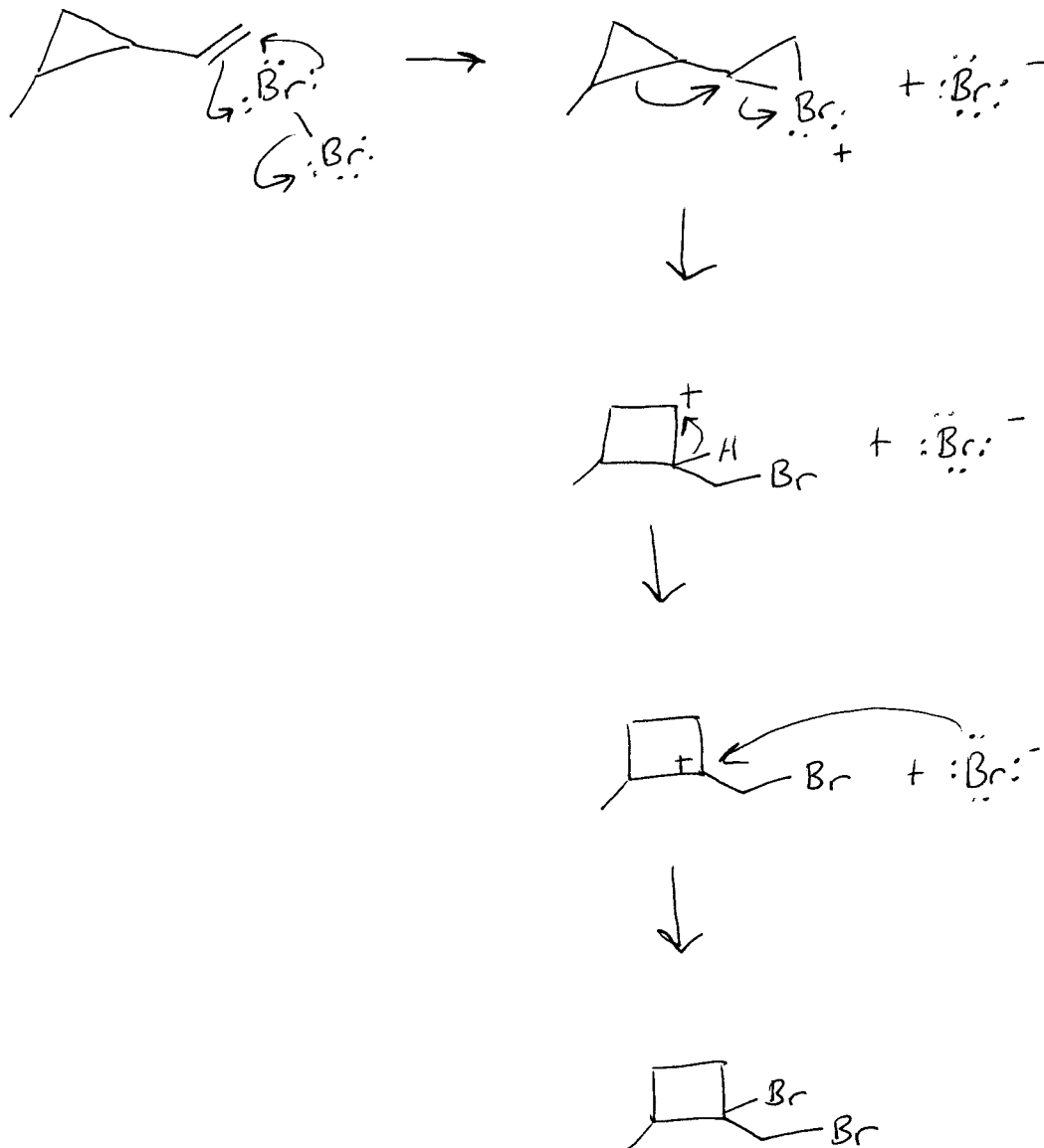
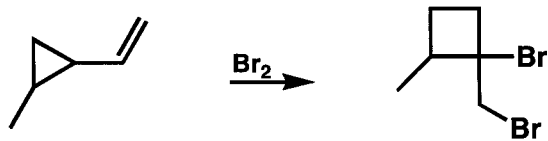

Initials

Points

EXTRA CREDIT

(5 pts) Provide mechanisms for the following reactions. Ignore stereochemistry.

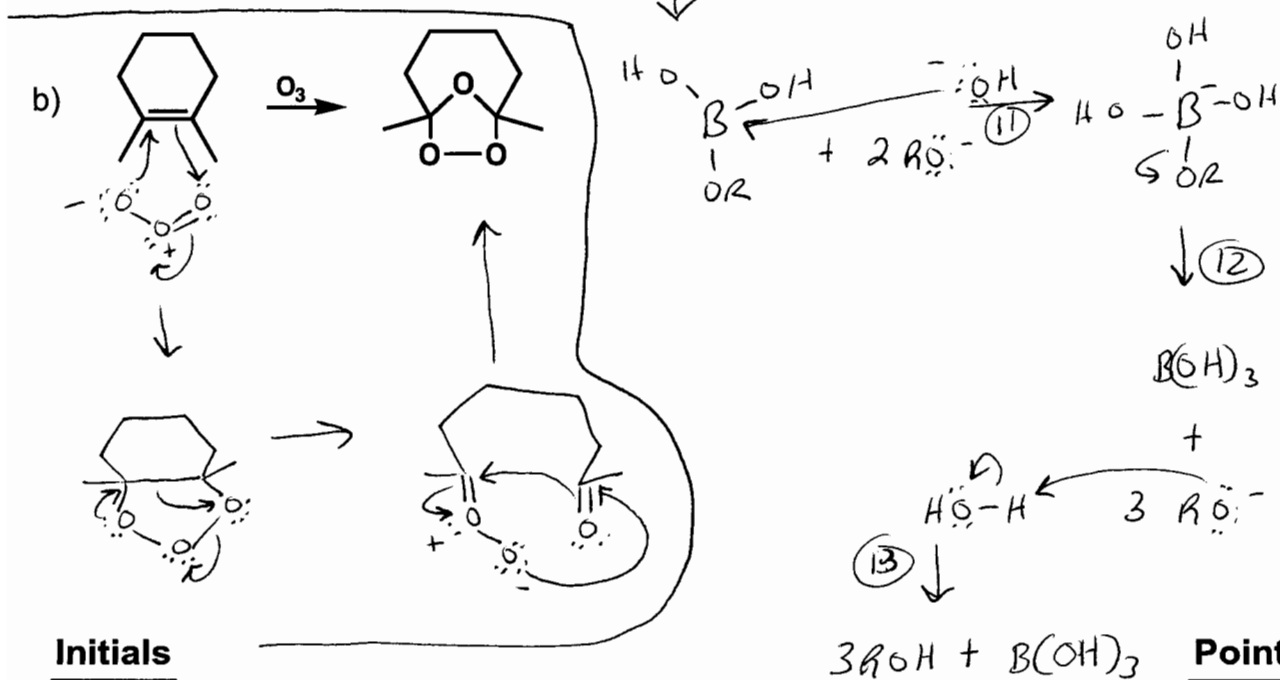
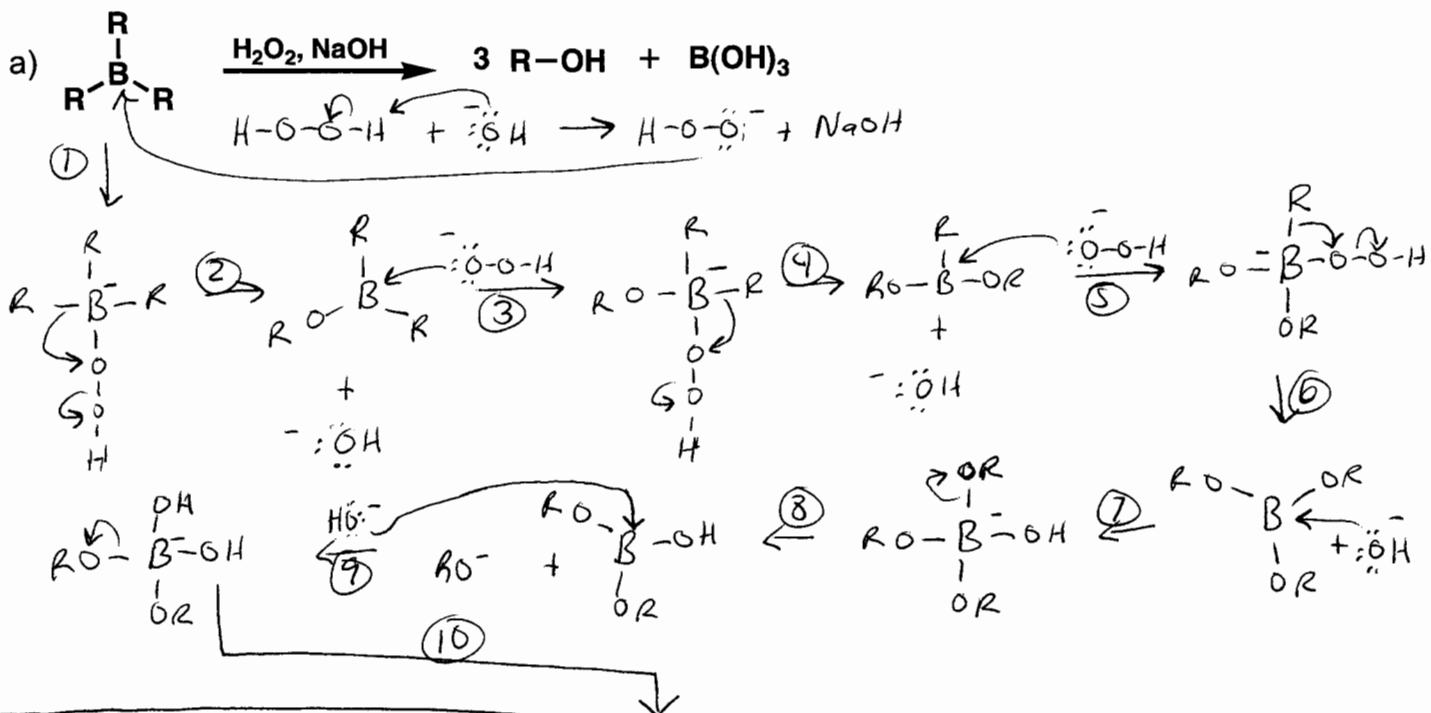

Initials

Points