

3.60 Symmetry, Structure and Tensor Properties of Materials

PRINCIPLES OF PLANE GROUP DERIVATION

(NOTE: THIS MATERIAL IS NOT TREATED IN THE TEXT!)

① SUMMARY OF PRINCIPLES IN ADVANCE (THAT IS, AN ABSTRACT)

(a) ADD EACH OF THE TWO-DIMENSIONAL POINT GROUPS TO EACH OF THE TWO-DIMENSIONAL LATTICE NETS WHICH CAN ACCOMMODATE THEM. EACH OF THE OPERATIONS OF THE POINT GROUP COMBINED WITH EACH OF THE INDEPENDENT LATTICE TRANSLATIONS WHICH TERMINATES WITHIN THE UNIT CELL MUST CREATE SOME NEW SYMMETRY OPERATION ELSEWHERE WITHIN THE CELL. LOCATE THESE USING THE "COMBINATION THEOREMS", EXPRESSIONS IN AN ALGEBRA OF OPERATIONS THAT SPECIFY THE NET EFFECT OF TWO SEQUENTIAL SYMMETRY TRANSFORMATIONS

$$T_{\perp} \cdot A_{\alpha} = B_{\alpha} @ \frac{T_{\perp}}{2} \text{ OR } \frac{B}{2}$$

$$T_{\perp} \cdot \sigma_{\pi} = \sigma'_{\pi} + T_{\parallel} @ \frac{1}{2} T_{\perp}$$

(b) SYMMETRY PLANES IN A POINT GROUP MUST BE MIRROR PLANES, BUT GLIDES ARE PERMITTED IN A PLANE GROUP AS IT IS TRANSLATIONALLY PERIODIC. REPLACE, THEREFORE, EACH OF THE PURE MIRROR PLANES IN THE POINT GROUPS OF (a) BY GLIDES, AND LOCATE THE ADDITIONAL SYMMETRY ELEMENTS WHICH ARISE USING THE ABOVE COMBINATION THEOREMS

(c) SYMMETRY PLANES AND AXES NEED NO LONGER INTERSECT IN A PLANE GROUP. THEREFORE, STARTING WITH THE PLANE GROUPS WHICH CONSIST OF ROTATION AXES (ALONE) PLACED IN A PLANE NET, ATTEMPT TO INTERLEAVE GLIDE PLANES OR MIRROR PLANES WITH THE AXES IN SUCH A WAY THAT NO NEW AXES ARE CREATED. FOR EACH POSSIBLE COMBINATION FIND THE NEW SYMMETRY ELEMENTS WHICH ARISE USING THE ABOVE COMBINATION THEOREMS AND THE NEW THEOREM:

$$\sigma_{\pi} \cdot A_{\pi} = \sigma'_{2\delta}$$

② THE TWO-DIMENSIONAL LATTICES (NETS)

EARLIER WE HAD SHOWN THAT ROTATION AND REFLECTION REQUIRE 5 TYPES OF TWO-DIMENSIONAL LATTICES, EACH WITH A DISTINCT SORT OF SPECIALIZATION WHICH IS DICTATED BY SYMMETRY

{ 1-fold OR 2-fold AXIS: PARALLELOGRAM NET
 4-fold AXIS: SQUARE NET
 3-fold OR 6-fold AXIS: EQUILATERAL (OR HEXAGONAL) NET
 MIRROR PLANE: EITHER A PRIMITIVE OR CENTERED (DIAMOND) RECTANGULAR NET

③ THE TWO-DIMENSIONAL POINT GROUPS

LET'S NOW ASK HOW ONE CAN COMBINE, ABOUT A FIXED POINT IN SPACE, MORE THAN ONE OF THE TWO-DIMENSIONAL SYMMETRY ELEMENTS WHICH CAN SUBSEQUENTLY BE COMBINED WITH A TWO-DIMENSIONAL LATTICE NET — NAMELY, 1, 2, 3, 4, 6 AND ∞ . A GROUND RULE THAT WE WILL IMPOSE IS THAT ALL MAPPINGS OF COORDINATES THAT OCCUR MUST INVOLVE ONLY THE TWO DIMENSIONS OF THE SPACE. WE WILL NOT ALLOW AN OPERATION THAT LIFTS A MOTIF OUT INTO A THIRD DIMENSION AND THEN RESTORES IT TO THE TWO-DIMENSIONAL SPACE OF OUR PLANE (ANY MORE THAN WE WOULD ENTERTAIN AN OPERATION IN THREE DIMENSIONS THAT PLUCKS THINGS OUT INTO A FOURTH DIMENSION AND THEN POPS THEM SUBSEQUENTLY BACK INTO THREE!)

THE SINGLE SYMMETRY ELEMENTS THAT MEET THIS RESTRICTION ARE

- (a) A ROTATION AXIS (NORMAL TO THE PLANE OF THE 2-D SPACE) WHICH MAPS THINGS ONLY WITHIN THE PLANE NORMAL TO THE AXIS
- (b) A MIRROR PLANE (NORMAL TO THE PLANE OF THE 2-D SPACE) WHICH MAPS THINGS LEFT-TO-RIGHT ACROSS THE MIRROR LINE.

If ROTATION AXES AND MIRROR LINES, SEPARATELY, ACT AS 2-DIMENSIONAL SYMMETRY ELEMENTS THAT LEAVE AT LEAST ONE POINT IN SPACE INVARIANT, THEY WILL CLEARLY DO SO IN COMBINATION, PROVIDED THEY INTERSECT AT A POINT (WHICH WILL BE THE LOCUS THAT IS LEFT INVARIANT).

If WE COMBINE TWO OPERATIONS, HOWEVER, WE WILL (LIKE IT OR NOT!) INTRODUCE A THIRD OPERATION INTO THE SPACE. WE WILL THUS NEED ANOTHER "COMBINATION THEOREM" THAT WILL, ONCE AND FOR ALL, SPECIFY THE RESULT.

(a) THE COMBINATION OF A ROTATION A_α WITH A REFLECTION σ ABOUT A LOCUS PASSING THROUGH A IS EQUIVALENT TO A NEW REFLECTION OPERATION σ' ABOUT A LOCUS $\alpha/2$ FROM THE FIRST

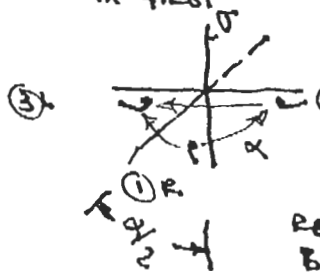

NOTE THAT THE INITIAL PAIR OF OPERATIONS DOES NOT COMMUTE! CHANGE THE ORDER AND THE RESULT IS AGAIN REFLECTION BUT ACROSS A DIFFERENT LOCATION - $\alpha/2$ ON THE OTHER SIDE OF THE INITIAL REFLECTION LOCUS

$$\sigma \cdot A_\alpha = \sigma'$$

(b) THE COMBINATION OF TWO SUCCESSIVE REFLECTION ACROSS LOCUS THAT INTERSECT AT A POINT

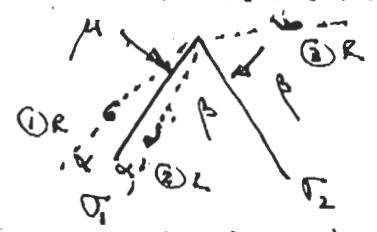

LET THE ANGLE BETWEEN σ_1 AND σ_2 BE DEFINED AS μ . THE SUCCESSIVE REFLECTION PRODUCE A THIRD MOTIF OF THE SAME HANDEDNESS - \therefore THE NET TRANSFORMATION MUST BE ROTATION THE AMOUNT OF ROTATION IS $(\alpha + \alpha + \beta + \beta)$ BUT $\alpha + \beta = \mu$ THUS

$$\sigma_2 \cdot \sigma_1 = A_{2\mu}$$

THE PAIR OF REFLECTION OPERATIONS DOES NOT COMMUTE EITHER. CHANGE THE ORDER AND THE RESULT IS $A_{-2\mu}$

THE NEW SYMMETRY COMBINATIONS THAT RESULT FROM APPLICATION OF EITHER OF THESE THEOREMS ARE

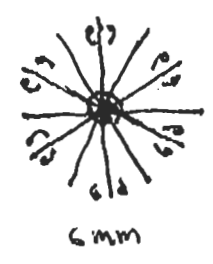
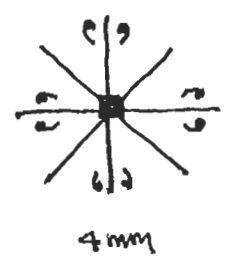
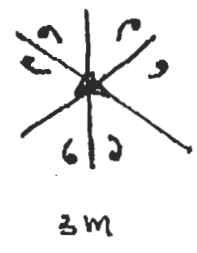
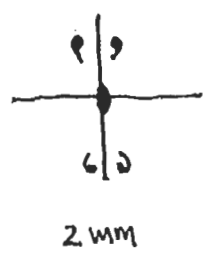

IT IS CONVENIENT TO HAVE A SYMBOL FOR EACH OF THE POSSIBLE COMBINATIONS. THERE ARE, IN FACT TWO!

THE INTERNATIONAL SYMBOL IS A RUNNING LIST OF THE INDEPENDENT SYMMETRY ELEMENTS THAT ARE PRESENT. ("INDEPENDENT" MEANS NOT RELATED TO ANOTHER BY SOME ^{OTHER} SYMMETRY ELEMENT. "INDEPENDENT" SYMMETRY ELEMENTS ARE ALSO "DIFFERENT" IN THE WAY IN WHICH MOTIFS ARE HUNG ON THEM.) NOTE THAT IN "4MM" FOR EXAMPLE, THE MIRROR LINES THAT ARE 45° FROM THE ADJACENT MIRROR LINES ARE NOT RELATED BY THE 90° ROTATION OF THE 4-FOLD AXIS. THEY ALSO DIFFER IN THE WAY THE CLOSEST PAIR OF MOTIFS ARE ARRANGED - DIFFERENT DISTANCE FROM THE MIRROR AND FACING IN A DISTINCT DIRECTION.

THUS THE COMBINATION OF 4 WITH A MIRROR PLANE LEADS TO 4MM (CONVENIENT, COUSE - IF WE LISTED ALL OF THE MIRRORS THAT WERE PRESENT IT WOULD BE "4MMMMMMMM") QUITE A MOUTHFUL !!)

NOTE THAT THE COMBINATION OF A 3-FOLD AXIS IS DIFFERENT IN THIS RESPECT: THERE IS ONLY ONE INDEPENDENT MIRROR AND THE SYMBOL USED IS THUS 3M

THE SCHÖNFLIES SYMBOL (AFTER ONE OF THE THREE INVESTIGATORS WHO INDEPENDENTLY AND ALMOST SIMULTANEOUSLY DERIVED THE 3-D SPACE GROUPS) IS BASED ON GROUP THEORY. "C" WAS USED TO DENOTE A "CYCLIC GROUP", DEFINED AS ONE IN WHICH ALL ELEMENTS ARE "POWERS" OF A BASIC OPERATION. (FOR EXAMPLE, 4 CONTAINS { A, A^2, A^3, A^4 } AS ELEMENTS. THE RANK OF AXIS IS APPENDED AS A SUBSCRIPT. 90° 180° 270° 360°

THUS C₄ FOR A 4-FOLD AXIS. ADDITION OF A "VERTICAL" (IN ANTICIPATION OF THE THREE-DIMENSIONAL) ANALOG) MIRROR PLANE IS INDICATED BY A "U" APPENDED TO THE SUBSCRIPT. M IS DENOTED BY "C_s" (IT IS A CYCLIC GROUP AND THE "S" REPRESENTS "SPIEGEL" - MIRROR IN GERMAN)

THE TWO DIMENSIONAL CRYSTALLOGRAPHIC POINT GROUPS ARE THUS

1	2	3	4	6	m	2mm	3m	4mm	6mm
C ₁	C ₂	C ₃	C ₄	C ₆	C _s	C _{2v}	C _{3v}	C _{4v}	C _{6v}

THEY ARE TERMED POINT GROUPS BECAUSE THE OPERATIONS (ELEMENTS) IN EACH CONFORM TO THE POSTULATES OF THE MATHEMATICAL ENTITY DEFINED AS A "GROUP" AND THESE OPERATIONS LEAVE AT LEAST ONE POINT IN SPACE INVARIANT. THE QUALIFIER "CRYSTALLOGRAPHIC" IS REQUIRED BECAUSE THESE ARE THE ONLY POINT GROUPS THAT ONE CAN COMBINE WITH A LATTICE. (THE POINT GROUPS 3MM OR 5M ARE QUITE LOVELY, BUT ONE COULD NEVER FIND THEM IN A CRYSTAL)

(NOTE SOME CONSEQUENCES OF THE GROUP RULES WHICH HAVE ESTABLISHED IN DEFINING THESE TWO-DIMENSIONAL POINT GROUPS:

THERE IS NO INVERSION CENTER IN TWO-DIMENSIONAL PATTERNS

IN 3-D THE MAPPING OF A 2-FOLD AXIS PARALLEL TO z IS $xy\bar{z} \rightarrow \bar{x}\bar{y}z$
THAT OF AN INVERSION CENTER IS $xy\bar{z} \rightarrow \bar{x}\bar{y}\bar{z}$ } THESE ARE INDISTINGUISHABLE IF THERE IS NO z COORDINATE!

THERE CAN BE NO 2-FOLD AXES LYING IN THE PLANE OF THE PATTERN

THIS OPERATION WOULD LIFT THE PATTERN OUT INTO THREE DIMENSIONS AND RESTORE I.E. TO THE TWO-DIMENSIONAL SPACE "UPSIDE-DOWN" — WHICH IS NOT DEFINED IN A STRICTLY TWO-DIMENSIONAL SPACE.

ONE COULD DERIVE SYMMETRIES IN WHICH THESE OPERATIONS WERE INCLUDED, AND THIS IN FACT WOULD LEAD TO SOMETHING CALLED THE "TWO-SIDED PLANE GROUPS" (e.g. A SHEET OF PAPER WITH PATTERN ON BOTH SURFACES) — BUT THESE ARE DIFFERENT BEASTS!

④ DISTRIBUTION OF 2-DIMENSIONAL POINT GROUPS AMONG THE 2-DIMENSIONAL LATTICES

THE 2-D-NETS REQUIRED BY A PURE ROTATION AXIS OR A PURE MIRROR PLANE ARE GIVEN ABOVE IN ②. WE NOW ASK WHETHER THE 2-D POINT GROUPS OF THE TYPE C_{nv} REQUIRE ANY NEW TYPES OF NETS WITH DISTINCT SORTS OF SPECIALIZATION.

2mm — EACH m REQUIRES THE NET TO BE RECTANGULAR (PRIMITIVE OR CENTERED)

THE 2-FOLD AXIS REQUIRES NO SPECIALIZATION

∴ 2mm REQUIRES EITHER OF THE RECTANGULAR NETS REQUIRED BY m

4mm — THE 4-FOLD AXIS REQUIRES THAT THE NET BE SQUARE

THE TWO m 'S REQUIRE THAT THEY BE ALONG THE EDGE OF A PRIMITIVE OR CENTERED RECTANGULAR NET. THIS SPECIALIZATION IS INCLUDED IN THAT INCORPORATED IN A SQUARE NET

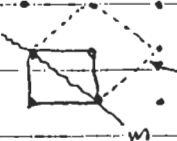

DOUBLE CELL = CENTERED SQUARE (ALSO A CENTERED RECTANGLE)

∴ 4mm REQUIRES ONLY THE SQUARE NET OF 4

3m & 6mm — THE 3-FOLD OR 6-FOLD AXIS REQUIRES AN EQUILATERAL NET

THE m 'S MUST BE ALONG THE EDGE OF A PRIMITIVE OR CENTERED RECTANGULAR NET. THIS SPECIALIZATION IS ALREADY INCLUDED IN THE EQUILATERAL NET AS IT IS A SPECIAL CASE OF A DIAMOND NET

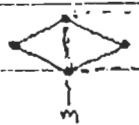

DOUBLE CELL IS A CENTERED RECTANGLE.

∴ 3m OR 6mm REQUIRES ONLY THE EQUILATERAL NET OF 3 OR 6



ANOTHER CHOICE FOR A CENTERED RECTANGLE

FOR FUTURE REFERENCE

NOTE THAT THERE ARE TWO ALLOWABLE SETTINGS FOR A MIRROR PLANE IN A HEXAGONAL NET: ALONG THE EDGE OF THE CELL OR NORMAL TO THE EDGE OF THE CELL

THE FINAL DISTRIBUTION OF THE 10 2-DIMENSIONAL POINT GROUPS AMONG THE 5 2-DIMENSIONAL LATTICES IS THIS

POINT GROUPS (10)	LATTICE TYPES (5)
1 2	PARALLELOGRAM
m 2mm	PRIMITIVE RECTANGLE OR CENTERED RECTANGLE (DIAMOND)
4 4mm	SQUARE
3 6 3m 6mm	EQUILATERAL

⑤ DERIVATION OF THE PLANE GROUPS

5.1 DIRECT ADDITION OF A POINT GROUP TO A LATTICE TYPE

TWELVE POTENTIAL PLANE GROUPS RESULT FROM THE DIRECT ADDITION OF THE 10 POINT GROUPS IN THE TABLE ABOVE TO THE LATTICE POINTS OF THE NETS WHICH CAN ACCOMMODATE THEM. AS A SYMBOL USED TO DESIGNATE EACH RESULT WE WILL USE A NOTATION WHICH CONSISTS OF TWO PARTS; A FIRST SYMBOL TO DESIGNATE THE LATTICE TYPE, AND A SECOND PART TO DESIGNATE THE POINT GROUP OR SYMMETRY WHICH HAS BEEN ADDED TO THE LATTICE POINT.

thus; for example:

A PARALLELOGRAM NET + POINT GROUP 2 ADDED TO A LATTICE POINT = PLANE GROUP P2

WE NEED NOT, IN THE SYMBOL FOR THE PLANE GROUP, SPECIFY THAT THE LATTICE IS A PARALLELOGRAM. (THE P STANDS FOR PRIMITIVE) AS THE INFORMED READER IS AWARE THAT POINT GROUP 2 REQUIRES ONLY THAT THE LATTICE BE AN UNSPECIALIZED PARALLELOGRAM. THUS THE ONLY TWO SYMBOLS WHICH APPEAR FOR LATTICE TYPES IN THE SYMBOLS FOR THE PLANE GROUPS ARE P (FOR PRIMITIVE) AND C (FOR CENTERED) AND, MOREOVER, THE LATTER IS NEEDED ONLY FOR THE CASE OF THE TWO RECTANGULAR NETS.

EVENTUALLY WE WILL DERIVE THREE-DIMENSIONAL SPACE GROUPS FOR WHICH SIMILAR SYMBOLS WILL BE USED. THERE IS, ACCORDINGLY, SOME SCOPE FOR AMBIGUITY: WE MIGHT, FOR EXAMPLE, ADD SYMMETRY 1 TO A PRIMITIVE, GENERAL TWO-DIMENSIONAL NET HERE, AND LATER ADD 1 TO A PRIMITIVE, GENERAL THREE-DIMENSIONAL SPACE LATTICE. TO DISTINGUISH 3-D SPACE GROUPS FROM 2-D PLANE GROUP SYMBOLS, AN UPPER-CASE LETTER IS USED FOR THE LATTICE TYPE OF THE FORMER, A LOWER-CASE LETTER FOR THE LATTICE TYPE OF THE LATTER.

thus P1 ⇒ 3-D SPACE GROUP
 p1 ⇒ 2-D PLANE GROUP

ADDITION OF A ROTATION AXIS TO A NET

PARALLELOGRAM NET + 1 = P1 

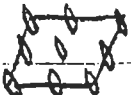
PARALLELOGRAM NET + 2 = P2 

SQUARE NET + 4 = P4 

Equilateral NET + 3 = $\boxed{P3}$



Equilateral NET + 6 = $\boxed{P6}$



COMBINATION THEOREM:

IN EACH OF THE ABOVE CASES WE HAVE ADDED A GROUP OF ROTATION OPERATIONS TO A LATTICE TRANSLATION WHICH IS PERPENDICULAR TO THE ROTATION AXIS. AS ALWAYS, THE COMBINATION OF TWO OPERATIONS IN A SPACE MUST CREATE THE PRESENCE OF A THIRD OPERATION. THE QUESTION THEN IS:

$T_{\perp} \cdot A_{\alpha} = ?$

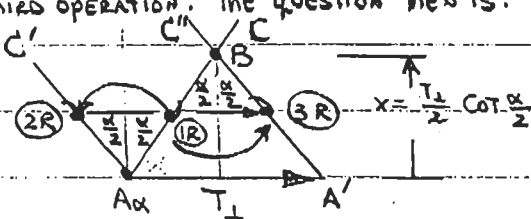

IN THE CONSTRUCTION TO THE LEFT

- ① COMBINE OPERATION A_{α} WITH A TRANSLATION T_{\perp} WHICH IS PERPENDICULAR TO IT
- ② CONSTRUCT A LINE AC WHICH MAKES AN ANGLE $\frac{\alpha}{2}$ WITH THE PERPENDICULAR TO THE PLANE OF A AND T_{\perp}

(NOTE THAT THIS IS A SPECIAL CASE AND WE WILL EVENTUALLY, WHEN WORKING WITH SPACE LATTICES, HAVE TO CONSIDER THE CASE WHERE THE TRANSLATION IS NOT PERPENDICULAR TO THE ROTATION AXIS)

- ③ THE ACTION OF A_{α} MAPS LINE AC TO A NEW LINE AC' $\frac{\alpha}{2}$ ON THE OTHER SIDE OF THE PERPENDICULAR (TAKING, FOR EXAMPLE, AN OBJECT ① WHICH IS RIGHT HANDED, SAY, TO OBJECT ②, ALSO RIGHT-HANDED

- ④ THE TRANSLATION T_{\perp} MAPS LINE AC' TO $A'C''$ (AND OBJECT ② TO ③)

⑤ HOW IS ① RELATED TO ③? NOT BY REFLECTION, AS THIS CHANGES THE "HANDEDNESS" OF THE OBJECT. NOT BY TRANSLATION, AS THE SEPARATION BETWEEN ① AND ③ DEPENDS ON THE LOCATION ALONG AC WHERE THE INITIAL OBJECT IS PLACED. THAT LEAVES ONLY ROTATION. THE LOCATION OF A ROTATION AXIS IS THE LOCUS OF POINTS LEFT UNMOVED BY THAT OPERATION; THE ONLY POINT ALONG AC WHICH IS UNMOVED IS POINT B , AT THE INTERSECTION OF AC AND $A'C''$, AND THIS POINT MAY BE SEEN TO BE LOCATED A DISTANCE $x = \frac{T_{\perp}}{2} \cot \frac{\alpha}{2}$ ALONG THE PERPENDICULAR BISECTOR OF T_{\perp} . NOTE ALSO, THAT THE ANGULAR THROW OF ROTATION AXIS B IS ALSO α , AND IN THE SAME SENSE AS A_{α} .

$T_{\perp} \cdot A_{\alpha} = B_{\alpha} @ \frac{T_{\perp}}{2} \cot \frac{\alpha}{2} \text{ ALONG } \perp\text{-BISECTOR OF } T_{\perp}$

THIS THEOREM WAS USED TO DERIVE THE LOCATION OF THE ADDITIONAL ROTATION AXES WHICH ARE DEPICTED ABOVE IN PLANE GROUPS $P1$ THROUGH $P6$. TO DO SO WE COMBINE EACH OF THE INDIVIDUAL ROTATION OPERATIONS IMPLIED BY THE PRESENCE OF THE ROTATION AXIS WITH EACH OF THE INDEPENDENT TRANSLATIONS WITHIN THE UNIT CELL (THERE ARE AN INFINITE NUMBER OF TRANSLATIONS IN A LATTICE, BUT THE NATURE OF A PLANE GROUP IS FULLY CHARACTERIZED BY THE CONTENTS OF A UNIT CELL; COMBINATION OF A ROTATION OPERATION WITH A VERY LONG TRANSLATION TO A LATTICE POINT FAR OUTSIDE THE CELL WILL OBVIOUSLY CREATE A ROTATION OPERATION WHICH IS ALSO FAR OUTSIDE THE CELL AND WHICH MUST BE TRANSLATION-EQUIVALENT TO ONE WITHIN THE CELL)

AS AN EXAMPLE WE DERIVE $P4$:

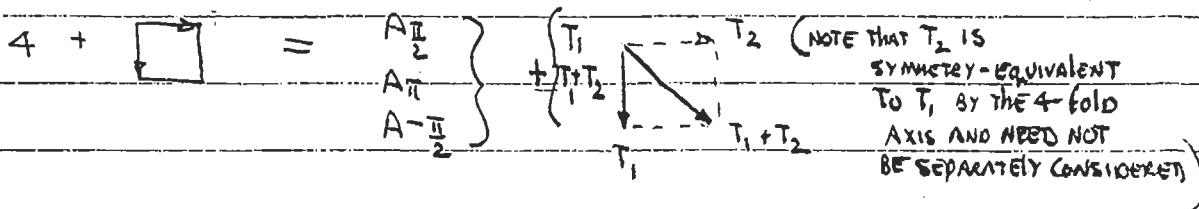

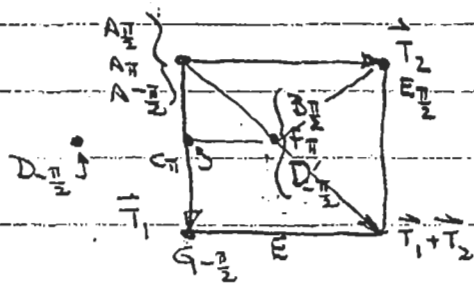

$$\begin{cases} \vec{T}_1 \cdot A_{II} = B_{II} @ \frac{T_1}{2} \cot 45^\circ = \frac{T_1}{2} \\ \vec{T}_1 \cdot A_{II} = C_{II} @ \frac{T_1}{2} \cot 90^\circ = 0 \\ \vec{T}_1 \cdot A_{II} = D_{II} @ \frac{T_1}{2} \cot -45^\circ = -\frac{T_1}{2} \equiv D'_{II} \text{ (REPEATED BY } T_2) \\ (\vec{T}_1 + \vec{T}_2) \cdot A_{II} = E_{II} @ |\vec{T}_1 + \vec{T}_2| \cot 45^\circ = \frac{1}{2}(\vec{T}_1 + \vec{T}_2) \\ (\vec{T}_1 + \vec{T}_2) \cdot A_{II} = F_{II} @ |\vec{T}_1 + \vec{T}_2| \cot 90^\circ = 0 \\ (\vec{T}_1 + \vec{T}_2) \cdot A_{II} = G_{II} @ |\vec{T}_1 + \vec{T}_2| \cot -45^\circ = -\frac{1}{2}(\vec{T}_1 + \vec{T}_2) \end{cases}$$

THUS WE HAVE $\left. \begin{matrix} C_{II} \\ T_{II} \\ D_{II} \end{matrix} \right\}$ all operations of 4-fold axis at center of cell

C_{II} } all operations of a 2-fold axis at midpoint of edge of cell

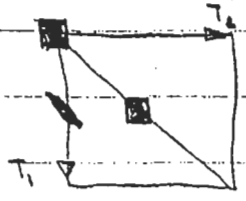

REPETITION OF THESE AXES BY TRANSLATION AND ROTATION \Rightarrow

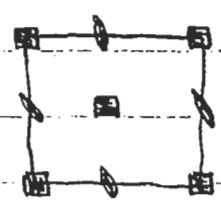

NOTE THAT THE 4-FOLD AXIS AT THE CENTER OF THE CELL IS INDEPENDENT AND NOT SYMMETRICALLY RELATED TO THE 4-FOLD AXIS AT THE ORIGIN. ALL 2-FOLD AXES ARE, HOWEVER, EQUIVALENT.

(THE OTHER COMBINATIONS OF A ROTATION AXIS WITH A NET ARE DERIVED IN DETAIL IN THE TEXT, PP 72-79)

ADDITION OF A MIRROR PLANE TO A NET.

COMBINATION THEOREMS: WE DERIVED THE PRIMITIVE RECTANGULAR NET BY ADDING A MIRROR PLANE NORMAL TO A TRANSLATION

$T_{\perp} \cdot M = ?$

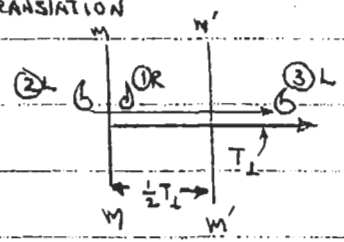

①R AND ③L ARE DIRECTLY RELATED BY A NEW MIRROR PLANE M', PARALLEL TO THE FIRST AND AT A DISTANCE 1/2 T_perp FROM THE FIRST.

THUS $T_{\perp} \cdot M = M' @ \frac{1}{2} T_{\perp}$

SUPPOSE NOW THAT THE COMBINATION IS MORE GENERAL AND THE TRANSLATION IS NO LONGER EXACTLY PERPENDICULAR TO THE MIRROR PLANE BUT INSTEAD HAS A COMPONENT T_perp WHICH IS NORMAL TO THE MIRROR PLANE AND A COMPONENT T_parallel WHICH IS PARALLEL

$T \cdot M = ?$

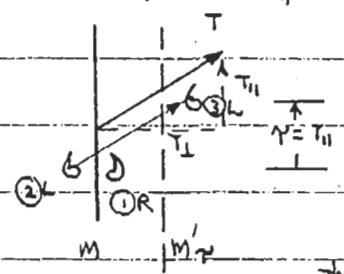

①R AND ③L MUST BE RELATED BY REFLECTION IN SOME WAY AS THEIR "HANDEDNESS" DIFFERS, BUT ③ IS NOT DIRECTLY ACROSS FROM ① AND INSTEAD IS SLID ALONG PARALLEL TO THE ORIENTATION OF THE ORIGINAL PLANE BY AN AMOUNT T_parallel

THERE IS NO WAY IN WHICH WE CAN USE ONE OF OUR BASIC OPERATIONS TO SPECIFY THE RELATION BETWEEN ① & ③. THEY ARE RELATED BY AN OPERATION WHICH CONTAINS TWO SEPARATE STEPS — REFLECTION IN A NEW PLANE (HALFWAY ALONG T_perp AS BEFORE) FOLLOWED BY TRANSLATION BY AN AMOUNT T_parallel. THIS IS A NEW TWO-STEP SYMMETRY OPERATION WHICH (AS IN THE CASE OF 4-bar) SIMPLY CANNOT BE DESCRIBED ANY MORE DIRECTLY. THE SYMMETRY ELEMENT IS CALLED A GLIDE PLANE, AND AN INDIVIDUAL OPERATION IS DESIGNATED M_gamma WHERE gamma IS THE TRANSLATION COMPONENT

$T \cdot M = M'_{\gamma} @ \frac{1}{2} T_{\perp}$

CHARACTERISTICS OF GLIDE : THE PATTERN PRODUCED BY A GLIDE CONSISTS OF ALTERNATING LEFT AND RIGHT-HANDED OBJECTS ON EITHER SIDE OF A PLANAR LOCUS, AND SEPARATED BY A TRANSLATION COMPONENT γ .

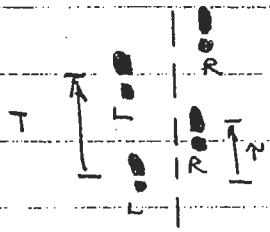

THE SYMBOL FOR AN INDIVIDUAL OPERATION IS M_γ
 THE SYMBOL FOR THE SYMMETRY ELEMENT ITSELF IS g IN TWO DIMENSIONS.
 (IN THREE DIMENSIONS WE WILL SUBSEQUENTLY ADOPT A NOTATION WHICH SPECIFIES THE ORIENTATION OF γ RELATIVE TO THE CELL EDGES)
 THE SYMBOL FOR DENOTING THE LOCUS OF A GLIDE PLANE (VIEWED EDGE-ON AND NORMAL TO γ) IN A PATTERN IS A DASHED LINE (AS OPPOSED TO A BOLD, SOLID LINE FOR m)

NOTE THAT PERFORMING THE GLIDE OPERATION TWICE PRODUCES A THIRD OBJECT WHICH IS TRANSLATION-EQUIVALENT TO THE FIRST. THAT IS, $M_\gamma^2 = T$. A CONSEQUENCE OF THIS IS THAT GLIDE CAN ONLY APPEAR IN A PATTERN WHICH IS TRANSLATIONALLY PERIODIC IN AT LEAST ONE DIMENSION.

FROM THE ABOVE, $T = 2\gamma$. OR, CONVERSELY, TURNING THIS AROUND, $\gamma = \frac{1}{2}T$. THUS IF WE ATTEMPT TO ADD A GLIDE PLANE TO A LATTICE, γ FOR A GLIDE PLANE MUST BE PARALLEL TO SOME TRANSLATION IN THE LATTICE, AND γ MUST BE EQUAL IN MAGNITUDE TO ONE-HALF OF THAT TRANSLATION. UPON ADDING A GLIDE PLANE TO A LATTICE, THEREFORE, WE ARE SPECIFYING BOTH T AND γ . LET US EXAMINE THE NATURE OF THE PATTERN PRODUCED. IF WE SPECIFY SOME γ LARGER THAN $\frac{1}{2}T$ (γ MUST STILL HOWEVER BE RELATED TO T AS PERFORMING THE GLIDE OPERATION TWICE IS EQUIVALENT TO TRANSLATION. ALL THAT IS STRICTLY REQUIRED, THOUGH, IS THAT 2γ BE AN INTEGRAL MULTIPLE OF T)

ASSUME, FOR EXAMPLE THAT $\gamma = \frac{3}{2}T$ (WITH $M_\gamma^2 = 3T$)

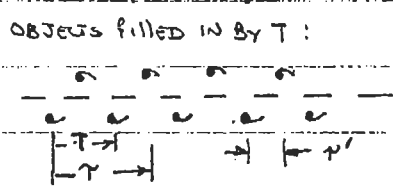
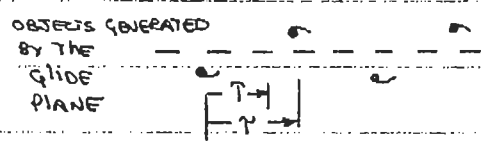

NOTE THAT THIS PATTERN IS INDISTINGUISHABLE FROM ONE WHICH WOULD BE GENERATED WITH $\gamma' = \frac{1}{2}T$

THUS, WHILE IT MAY BE USEFUL TO SPECIFY A RELATION BETWEEN A PARTICULAR PAIR OF OBJECTS BY A GLIDE OPERATION WITH $\gamma > \frac{1}{2}T$ (ONE, FOR EXAMPLE, MAY ARISE AS THE RESULT OF APPLICATION OF A COMBINATION THEOREM), THE VALUE OF γ FOR A GLIDE PLANE MAY ALWAYS BE REDEFINED BY THE ADDITION OR SUBTRACTION OF AN INTEGRAL NUMBER OF TRANSLATIONS SUCH THAT γ IS ALWAYS EITHER 0 OR $\frac{1}{2}T$

MOST GENERAL THEOREM FOR COMBINATION OF A SYMMETRY PLANE WITH A TRANSLATION: THE TWO THEOREMS ON PG 5 MAY BE GENERALIZED TO THE MOST GENERAL CASE - COMBINATION OF A GLIDE PLANE WITH A TRANSLATION INCLINED TO IT

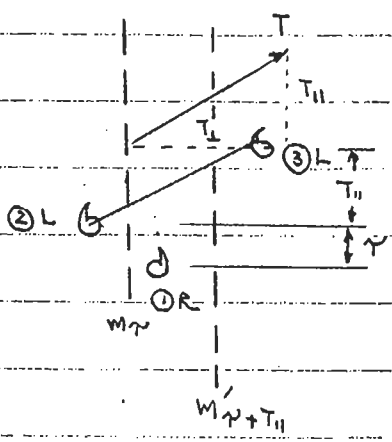

OBJECT 1 IS NOW RELATED TO 3 DIRECTLY BY A NEW PLANE, PARALLEL TO THE FIRST AND LOCATED $\frac{1}{2}T_{\perp}$ AWAY (AS BEFORE), AND WITH A GLIDE TRANSLATION-COMPONENT EQUAL TO THE SUM OF γ OF THE ORIGINAL GLIDE PLUS T_{\parallel}

$$T \cdot M_\gamma = M_{\gamma+T_{\parallel}} @ \frac{1}{2}T_{\perp}$$

NOTE THAT ALL PRECEDING THEOREMS OF THIS FAMILY ARE SPECIAL CASES OF THIS RESULT WITH γ AND/OR T_{\parallel} EQUAL TO ZERO SINCE THE NEW GLIDE COMPONENT, γ' IS EQUAL TO $\gamma + T_{\parallel}$ WE MAY HAVE TO SUBTRACT AN INTEGRAL TRANSLATION TO ESTABLISH WHETHER THE NEW PLANE IS A MIRROR OR GLIDE

HAVING OBTAINED THE THEOREMS NECESSARY TO DEDUCE THE NEW SYMMETRY ELEMENTS WHICH ARISE WHEN A MIRROR PLANE OR GLIDE PLANE IS COMBINED WITH TRANSLATION, LET'S CONTINUE WITH DERIVATION OF THE PLANE GROUPS WHICH RESULT FROM DIRECT ADDITION OF A POINT GROUP TO A LATTICE POINT

M + PRIMITIVE RECTANGULAR NET



$$T_1 \cdot M = M'_{T_1} \equiv M' \text{ @ } 0 \text{ ALONG } T_1 \text{ (ie, ON TOP OF ORIGINAL } M \text{) NOTHING NEW}$$

$$T_2 \cdot M = M' \text{ @ } \frac{1}{2} \text{ ALONG } T_2 \text{ THIS IS A NEW } M \text{ THROUGH THE CENTER OF THE CELL}$$

$$(T_1 + T_2) \cdot M = M'_{T_1+T_2} \equiv M' \text{ @ } \frac{1}{2} T_2 \text{ SAME AS THE ABOVE MIRROR PLANE}$$

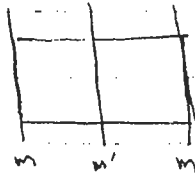

Pm

M + CENTERED RECTANGULAR NET

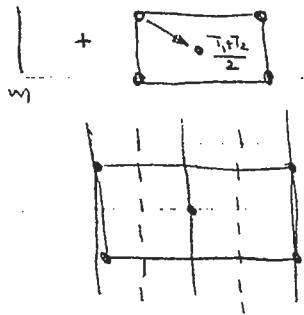

CONTAINS ALL OF THE OPERATIONS ABOVE FOR Pm PLUS

THE ADDITIONAL TRANSLATION $\frac{T_1+T_2}{2}$ TO THE CENTERED LATTICE POINT

$$\left(\frac{T_1+T_2}{2}\right) \cdot M = M'_{\frac{T_1+T_2}{2}} \text{ @ } \frac{1}{2} \cdot \frac{1}{2} T_2 \text{ THIS IS A NEW GLIDE PLANE WITH } P \text{ @ } \frac{1}{2} T_1 \text{ LOCATED } \frac{1}{4} \text{ OF THE WAY ALONG } T_2.$$

(A SECOND GLIDE $\frac{3}{4}$ OF THE WAY ALONG T_2 IS REPEATED FROM THE FIRST BY TRANSLATION $\frac{T_1+T_2}{2}$)

Cm

NOTE THE USE, FOR THE FIRST TIME, OF A 'C' TO INDICATE A CENTERED LATTICE (THE 'M' TELLS YOU ITS RECTANGULAR)

2MM + PRIMITIVE RECTANGULAR NET

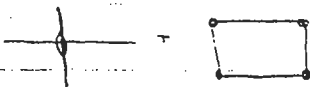

THIS INVOLVES ALL OF THE STEPS OF P2 PLUS ALL OF THE STEPS OF Pm FOR MIRROR PLANES ALONG BOTH EDGES OF THE CELL. THE WORK HAS ALREADY BEEN DONE AND THE RESULT IS OBVIOUSLY

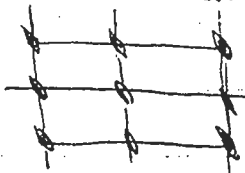

P2mm

2MM + CENTERED RECTANGULAR NET

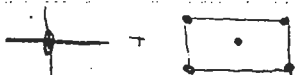

THIS IS ALL OF THE STEPS OF P2 PLUS ALL OF THE STEPS OF Cm FOR M'S IN 2 ORIENTATIONS. THE WORK HAS ALREADY BEEN DONE AND THE RESULT IS

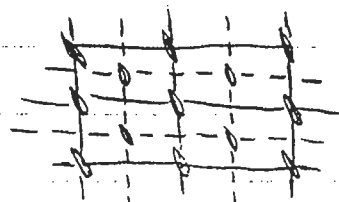

C2mm

(--- THIS IS THE HINT, SO FAR OBTAINED, IF ANYBODY IS COUNTING)

4MM: + SQUARE NET

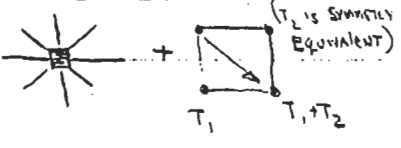

THE 4-fold axis + HAS ALREADY BEEN DONE IN P4

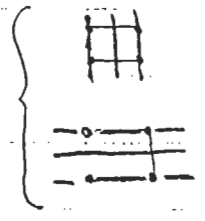
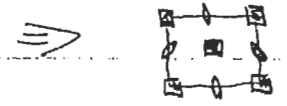
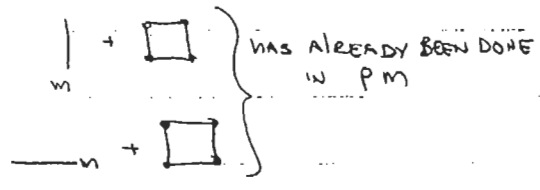

WHICH LEAVES

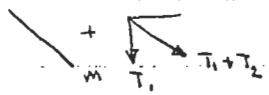

TO BE CONSIDERED (THE OTHER DIAGONAL MIRROR PLANE 90° AWAY IS SYMMETRY-EQUIVALENT)

$(T_1 + T_2) \cdot m = m'_{T_1 + T_2} \equiv m$ ON TOP OF THE ORIGINAL m (T IS \parallel TO m) NOTHING NEW

$T_1 \cdot m = m'_{T_1} @ \frac{1}{2} T_{\perp}$ WHERE $|T_{\parallel}| = |T_{\perp}| = T_1 \cos 45^\circ = \frac{T_1}{\sqrt{2}}$

THIS IS A NEW GLIDE PLANE

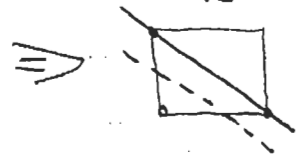

REPEATING PLANES BY SYMMETRY (e.g. ROTATING THE NEW GLIDE AT 90° INTERVALS ABOUT THE CENTER OF THE CELL.)

GIVES

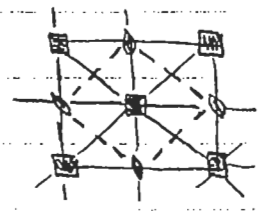

P4mm

3M + EQUILATERAL NET

HERE WE ENCOUNTER A CURIOUS SITUATION: THE EQUILATERAL NET HAS POTENTIALLY A MUCH HIGHER SYMMETRY THAN 3M AND THERE ARE TWO POSSIBLE ORIENTATIONS FOR ONE AND THE SAME POINT GROUP IN THE LATTICE

#1

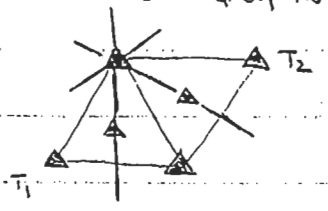

#2

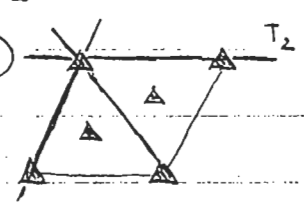

THE 3-FOLD AXIS MAKES T_1 , T_2 , AND $-(T_1 + T_2)$ SYMMETRY-EQUIVALENT, AND ALL 3 MIRROR PLANES ARE EQUIVALENT, SO WE NEED

COMBINE ONLY 1 MIRROR WITH T , AND REPRODUCE THE RESULT BY SYMMETRY

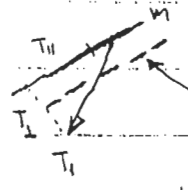

$T_1 \cdot m = m'_{T_1} @ \frac{1}{2} T_{\perp}$
GLIDE COMPONENT IS $T_1 \cos 30^\circ = T_1 \frac{\sqrt{3}}{2}$
THIS IS $\frac{1}{2}$ OF THE LONG DIAGONAL OF THE CELL.

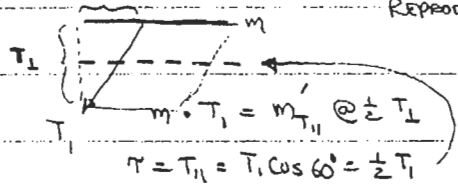

$T_1 \cdot m = m'_{T_1} @ \frac{1}{2} T_{\perp}$
 $T_{\perp} = T_1 \cos 60^\circ = \frac{1}{2} T_1$

REPETITION OF THIS GLIDE BY ROTATION WITH THE TWO 3-FOLD AXES IN THE INTERIOR OF THE CELL AND ADDITION OF 3M TO EVERY LATTICE POINT GIVES

REPETITION OF THIS GLIDE BY ROTATION WITH THE TWO 3-FOLD AXES IN THE INTERIOR OF THE CELL GIVES:

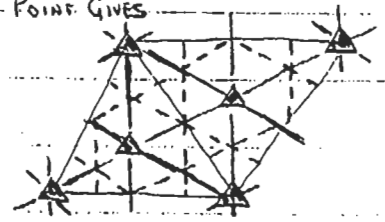

P3m1

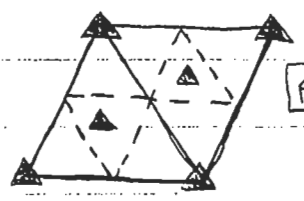

P31m

A THOUGHT BEFORE TURNING THE PAGE; NOTE THAT THE POINT GROUPS ABOVE ALL CONTAIN (a) AXES IN THE USUAL LOCATIONS (b) MIRROR PLANES OF THE POINT GROUP HUNG AT LATTICE POINTS. WHENEVER A MIRROR IS INCLINED TO A TRANSLATION IN THE NET THE EFFECT IS TO INTERLEAVE GLIDES BETWEEN ALL THE MIRROR PLANES

IN THE ABOVE, THE CONVENTION WHICH WE HAVE USED FOR ESTABLISHING LABELS FOR THE PLANE GROUPS falls short — WE CAN'T SIMPLY CALL IT P3M BECAUSE FOR THE FIRST TIME WE HAVE OBTAINED TWO DISTINCT PLANE GROUPS FROM ONE AND THE SAME POINT GROUP! ANOTHER CONVENTION IS NEEDED TO DISTINGUISH BETWEEN THESE RESULTS. THE RULE IS TO INTRODUCE ANOTHER CHARACTER INTO THE POINT GROUP PART OF THE SYMBOL TO SPECIFY THE SYMMETRY WHICH IS ALONG THE DIAGONAL OF THE CELL (THE LONG DIAGONAL; THE SHORT ONE IS SYMMETRY-EQUIVALENT TO THE CELL EDGE) AS WELL AS THE SYMMETRY ALONG THE CELL EDGE:
 THE ORDER OF SYMBOLS IS

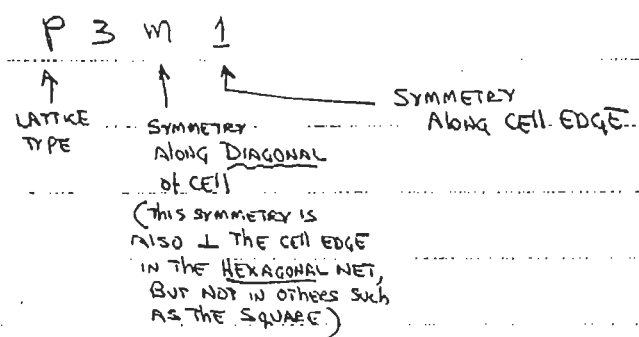

HAPPILY, THIS SITUATION OCCURS ONLY FOR POINT GROUP 3M !!

6mm + EQUILATERAL NET WE HAVE ALREADY DONE ALL THE WORK FOR THIS COMBINATION. AXES (6, 3, 2-fold) OCCUR IN ALL OF THE LOCATIONS OF P6. WE NOTE THAT THE MIRROR PLANES IN 6mm ARE 30° APART, SO THE ADDITION OF 6mm TO THE LATTICE WILL PLACE MIRRORS IN THE LOCATIONS OF BOTH P31M AND P3M1. THE ARRANGEMENT OF MIRRORS AND GLIDES WHICH THIS RESULTS IS SIMPLY THAT FOR P31M SUPERPOSED UPON P3M1. (WE WILL UNAPOLOGETICALLY NOT TRY TO SKETCH THIS ONE, AND MERELY POINT...)

P6mm

A DRAWING OF THE INTRICATE ARRANGEMENT OF SYMMETRY PLANES IN THIS PLANE GROUP IS CONTAINED IN THE HANDOUT REPRODUCED FROM THE INTERNATIONAL TABLES FOR X-RAY CRYSTALLOGRAPHY

5.2 Replacement of Mirror Planes by Glide Planes

THUS FAR WE HAVE OBTAINED 13 PLANE GROUPS THROUGH DIRECT ADDITION OF POINT GROUPS TO THE 2-DIMENSIONAL LATTICES. THIS MIGHT SEEM TO EXHAUST ALL POSSIBILITIES. BUT, IN THE PROCESS OF THESE DERIVATIONS, WE WERE BROUGHT INTO HEADLONG CONFRONTATION WITH THE GLIDE PLANE, A SYMMETRY ELEMENT WHICH WE HAD NOT ENCOUNTERED EARLIER AS IT EXISTS ONLY IN TRANSLATIONALLY PERIODIC PATTERNS AND THUS PLAYS NO ROLE IN THE POINT GROUPS.

IN CONSIDERING THE SPACE GROUPS, HOWEVER, ONE IS DEALING BY DEFINITION WITH PATTERNS THAT ARE TRANSLATIONALLY PERIODIC, SO GLIDE PLANES MAY BE PRESENT. ONE MIGHT ASK THEN, WHETHER ADDITIONAL PLANE GROUPS MIGHT BE OBTAINED BY REPLACING MIRROR PLANES IN THE TWO-DIMENSIONAL POINT GROUPS BY GLIDES (WHICH ARE, INDEED, A GENERALIZATION OF A MIRROR PLANE IN THAT M IS A GLIDE WITH T=0) WHEN TWO INDEPENDENT MIRROR PLANES ARE PRESENT IN A POINT GROUP, WE MIGHT REPLACE ONE OR BOTH BY GLIDES. THE FOLLOWING REPLACEMENTS OF M'S BY G'S IN A POINT GROUP THUS PRESENT THEMSELVES AS POSSIBILITIES WHICH SHOULD BE COMBINED WITH THE PLANE NETS.

- M → g
- 2mm → 2mg OR 2gg
- 3m → 3g
- 6mm → 6mg OR 6gg

REPLACING m BY g : ADDITION OF g TO PRIMITIVE RECTANGULAR NET

$\frac{1}{2}T_1 = \tau \downarrow$ + 

$T_1 \cdot M_{\tau} = M'_{\tau+T_1} @ 0$ Along $T_2 \equiv M_{\tau}$ SAME GLIDE ON TOP OF ITSELF (Nothing New)
 $T_2 \cdot M_{\tau} = M'_{\tau+0} @ \frac{1}{2}$ Along T_2 A NEW GLIDE HALFWAY ALONG THE CELL
 $(\vec{T}_1 + \vec{T}_2) \cdot M_{\tau} = M'_{\tau+T_1} \equiv M'_{\tau} @ \frac{1}{2}$ ALONG T_2 SAME NEW GLIDE AS ABOVE

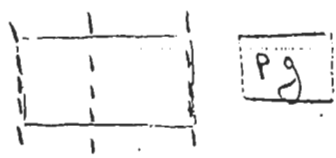

ADDITION OF g TO CENTERED RECTANGULAR NET

$\frac{1}{2}T_1 = \tau \downarrow$ + 

SAME COMBINATIONS OF OPERATIONS AS ABOVE IN Pg EXCEPT FOR THE NEW TRANSLATION $\frac{1}{2}(\vec{T}_1 + \vec{T}_2)$ TO THE CENTERED LATTICE POINT
 $(\frac{\vec{T}_1 + \vec{T}_2}{2}) \cdot M_{\tau} = M'_{\tau + \frac{1}{2}T_1} \equiv M'_{\tau} @ \frac{1}{4}T_2$ A NEW M $\frac{1}{4}$ ALONG T_2

THIS SYSTEM OF INTERFERRED M 'S AND g 'S IS EXACTLY THAT FOUND FOR CM (RECALL THAT THERE IS NO UNIQUE ORIGIN TO A TRANSLATION AND NO UNIQUE LOCATION FOR THE LATTICE POINT)
 THUS " cg " IS IDENTICAL TO CM

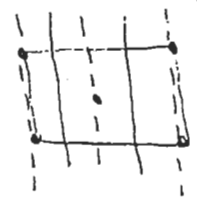

2MM WITH ONE m REPLACED BY g

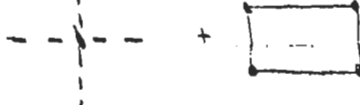

 THIS COMBINATION IS IMPOSSIBLE. WE HAVE A THEOREM THAT STATES $m_1 \cdot A_{\pi} = m_2$
 SO IF ONE PLANE PASSING THROUGH THE AXIS IS A MIRROR, THE SECOND PLANE MUST ALSO BE A MIRROR.

2MM WITH BOTH m 'S REPLACED BY g

 THE PLANE GROUP $C2MM$ (OBTAINED BY ADDING 2MM TO A LATTICE POINT) WAS FOUND TO CONTAIN A 2-FOLD AXIS WHICH HAD TWO GLIDES PASSING THROUGH IT. IT THUS WOULD NOT BE AT ALL SURPRISING TO DISCOVER THAT IF WE BEGAN BY ADDING 2GG A NEW LOCATION WITH SYMMETRY 2MM WOULD APPEAR AND THE RESULT TURN OUT TO BE IDENTICAL TO $C2MM$. LET'S SHOW THAT THIS IS THE CASE.

2gg + PRIMITIVE RECTANGULAR NET HAS ALL THE COMBINATIONS OF $P2$ AND Pg (IN TWO ORIENTATIONS)

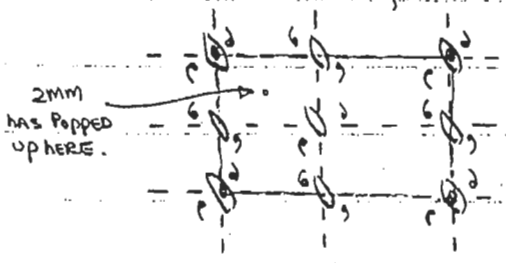
THEREFORE, ON THE BASIS OF EARLIER COMBINATIONS, THE RESULT IS AS SHOWN TO THE LEFT



WE HAVE NOT YET DEVELOPED A COMBINATION THEOREM THAT TELLS US WHAT THE ADDITION OF A 2-FOLD AXIS TO A GLIDE  IS EQUIVALENT TO (WE WILL DO SO IN THE NEXT SECTION) BUT IF WE DRAW IN THE PATTERN OF $P2$ WHICH IS GENERATED BY THE 2-FOLD AXIS, AND THEN REPEAT THESE OBJECTS WITH THE GLIDES, WE GET THE PATTERN SHOWN TO THE LEFT. THIS PATTERN IS IDENTICAL TO THAT OF $C2MM$ REFERRED TO A DIFFERENT ORIGIN. MOREOVER, LOCATIONS OF SYMMETRY 2MM ARE PRESENT AT $\frac{1}{4}, \frac{3}{4}, \frac{5}{4}, \frac{7}{4}$ (ANTICIPATING THE COMBINATION THEOREM WE WILL DERIVE). IN ADDITION, THE LATTICE HAS BEEN CHANGED FROM A PRIMITIVE RECTANGULAR NET TO A CENTERED NET

THE REASON FOR THIS MAY BE UNDERSTOOD BY PERMUTING A COMBINATION THEOREM WE HAVE

PREVIOUSLY OBTAINED $T_{\perp} \cdot A_{\pi} = B_{\pi} @ 0$ ALONG \perp BISECTOR

THEREFORE, TWO SUCCESSIVE ROTATIONS OF π ABOUT PARALLEL AXES IS EQUIVALENT TO A TRANSLATION EQUAL TO TWICE THE SEPARATION OF THE AXES

$$B_{\pi} \cdot A_{\pi} = T_{\perp}$$

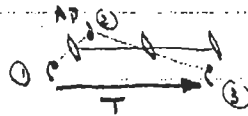

THIS THE PRESENCE OF A_{π} AT THE ORIGIN, COMBINED WITH THE OPERATION B_{π} , WHICH HAS APPEARED AT $\frac{1}{2}(T_1 + T_2)$ REQUIRES THAT $\frac{1}{2}(T_1 + T_2)$ BE A TRANSLATION

REPLACEMENT OF ONE m IN $4mm$ BY g

THIS COMBINATION IS AGAIN IMPOSSIBLE - THE THEOREM



$$m_1 \cdot A_{\pi} = m_2$$

$\frac{1}{2} T_{\perp}$

REQUIRES THAT BOTH PLANES BE m IF ONE IS A MIRROR

REPLACEMENT OF BOTH m 'S IN $4mm$ BY g



THIS COMBINATION IS IMPOSSIBLE. A GLIDE CANNOT BE PLACED PARALLEL TO THE CELL EDGE OF $P4$ AS IT DOES NOT LEAVE THE AXES INVARIANT

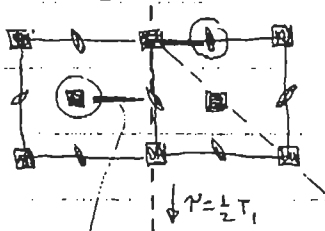

THIS WOULD ALSO HAVE TO BE A 2-FOLD AXIS IF A GLIDE WERE PRESENT

ADDITION OF $3g$, $3ig$ OR $6gg$ TO THE EQUILATERAL NET. ($6gg$ IS IMPOSSIBLE)

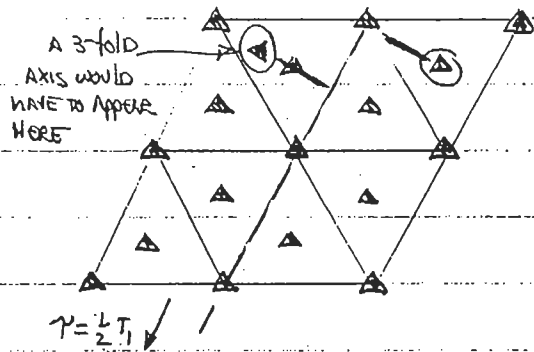
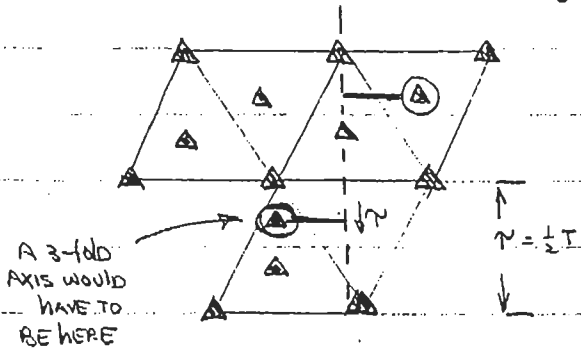

GLIDES ARE IMPOSSIBLE IN THESE ORIENTATIONS AS THEIR OPERATION DOES NOT LEAVE THE POSITIONS OF THE ROTATION AXES INVARIANT.

5.3. INTERLEAVING OF PLANES WITH AXES

TO THIS POINT WE HAVE DERIVED 14 DISTINCT PLANE GROUPS AND THE WEARY READER HAS NO DOUBT SIGNED "SURELY WE HAVE NOW EXHAUSTED ALL THE POSSIBILITIES!". NOT QUITE YET. THE POTENTIAL COMBINATIONS WE HAVE THUS FAR EXAMINED HAVE ALL INVOLVED THE ADDITION OF EITHER A POINT GROUP (AXES; PLANES, OR PLANES PASSING THROUGH AXES) DIRECTLY TO A LATTICE POINT, OR A SIMILAR ADDITION IN WHICH ONE OR MORE OF THE MIRROR PLANES IN A POINT GROUP HAVE BEEN REPLACED BY A GLIDE. IN ALL OF THESE ADDITIONS ALL SYMMETRY ELEMENTS INTERSECTED AT A COMMON POINT WHICH, BY DEFINITION, THEY MUST DO IN A POINT GROUP AS A POINT IN SPACE MUST BE LEFT UNMOVED. THE PLANE GROUPS, HOWEVER, CONTAIN SYMMETRY ELEMENTS DISTRIBUTED THROUGHOUT SPACE; THERE IS NO LONGER ANY REASON, THEREFORE, WHY THE PLANES AND AXES WHICH WE ADD TO A LATTICE HAVE TO INTERSECT AT A COMMON POINT. AS THE FINAL STEP IN OUR DERIVATION WE SHOULD CONSIDER LOCATIONS WHERE, AFTER ADDING AXES TO A NET, WE CAN INTERLEAVE MIRROR PLANES OR GLIDE PLANES. THERE IS A CONSTRAINT IN DOING THIS; THE INTERLEAVED PLANES CANNOT CREATE ANY NEW TRANSLATIONS THROUGH THEIR OPERATION (FOR THIS WOULD CHANGE THE LATTICE NET WITH WHICH WE STARTED) NOR CAN IT CREATE ANY NEW ROTATION AXES (FOR THESE, IN TURN, WOULD CREATE NEW LATTICE POINTS THROUGH THEIR ACTION OR, ALTERNATIVELY, CREATE NEW TRANSLATIONS BY VIRTUE OF THE TRANSDUCED COMBINATION THEOREM $R_{\alpha} \cdot A_{\alpha} = T$ ($R_{\alpha} \& A_{\alpha}$ PARALLEL) WHICH WE ENCOUNTERED EARLIER AT THE TOP OF PG (II))

LET'S CONSIDER THE COMBINATIONS OF ROTATION AXES WITH THE PLANE NETS AND EXAMINE THEM FOR POTENTIAL LOCATIONS AT WHICH ONE MIGHT INTERLEAVE MIRRORS OR GLIDES (WE NEED NOT CONSIDER THE PARALLELOGRAM NET AS m OR g REQUIRES THAT ITS NET BE AT LEAST RECTANGULAR)

2 + PRIMITIVE RECTANGULAR NET

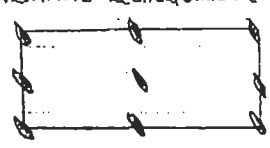

POTENTIAL LOCATIONS FOR INTERLEAVED m OR g

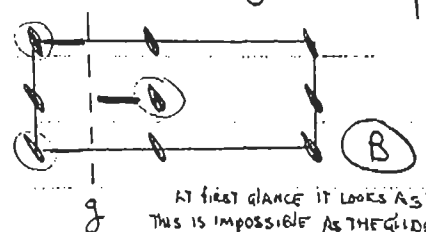
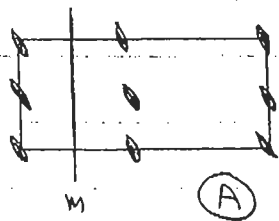

(WE WILL NOT REGARD THE INTERLEAVING OF m OR g IN AN ORIENTATION 90° FROM THAT SHOWN AS BEING DISTINCT AS THERE IS NOTHING SPECIAL ABOUT ONE EDGE OF THE RECTANGULAR CELL OR THE OTHER.)

AT FIRST GLANCE IT LOOKS AS THOUGH THIS IS IMPOSSIBLE AS THE GLIDE WOULD SEEM TO CREATE A NEW LATTICE POINT AT THE CENTER OF THE CELL. REMEMBER, HOWEVER, THAT THERE IS NO UNIQUE PLACEMENT OF A LATTICE POINT: NO UNIQUE ORIGIN TO THE OPERATION OF TRANSLATION — ALL THAT IS SPECIFIED IS THE DIRECTION AND INTERVAL OF THE TRANSLATIONAL REPETITION. THUS, THE ACTION OF THE GLIDE, ABOVE, IS TO REPEAT TRANSLATION T_2 THUSLY:

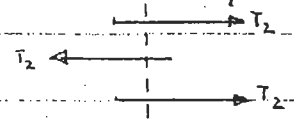

THIS CHANGES NEITHER THE MAGNITUDE OR DIRECTION OF T_2 AND, AS T_2 HAS NO UNIQUE ORIGIN, IS QUITE ACCEPTABLE

2 + CENTERED RECTANGULAR NET

$2T_1 =$ A TRANSLATION EQUAL TO $\frac{1}{2}T_2$ WHICH IS NOT PRESENT IN THIS LATTICE

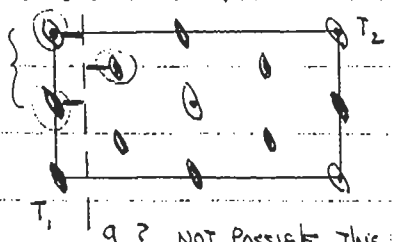

Nothing possible.

g ? NOT POSSIBLE. THIS COMBINATION CREATES NO NEW 2-FOLD AXES, BUT $m_{\perp}^2 = \frac{1}{2}T_1$. THIS CREATES A NEW TRANSLATION $T = \frac{T_1}{2}$ IN THE LATTICE AND THUS CHANGES THE LATTICE. THIS COMBINATION REDUCES TO (B) ABOVE.

4 + SQUARE NET

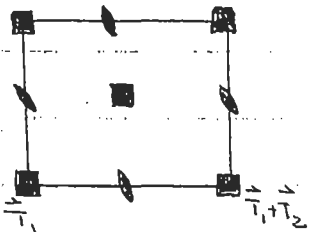

POTENTIAL LOCATIONS FOR INTERLEAVED m OR g

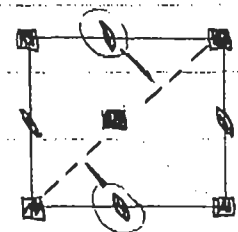

(C)

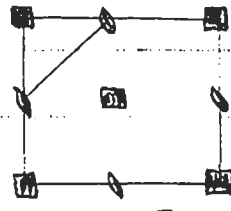

(D)

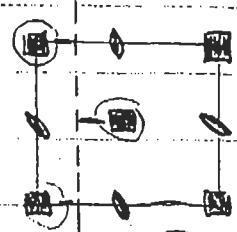

(E)

3 + EQUILATERAL NET

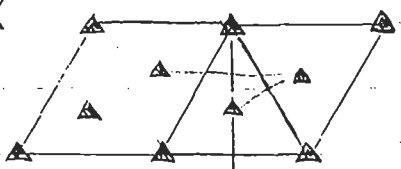
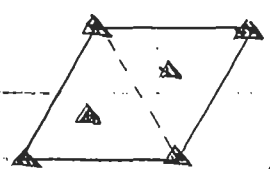

SIMILAR TO WHAT WE TRIED IN PLACING 4gg AT A LATTICE POINT, BUT NOW WE ARE NOT ADDING A PAIR OF GLIDES 46° APART, BUT ONLY ONE

NOT STRICTLY AN INTERLEAVED MIRROR PLANE, BUT A m CAN BE ACCOMMODATED IN THIS POSITION AND IN P4MM g OCCUPIES THIS LOCATION

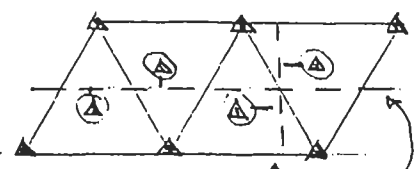

m's MAY BE ACCOMMODATED ONLY IN THESE POSITIONS (OR SYMMETRICALLY-EQUIVALENT LOCATIONS) AND WE HAVE ALREADY USED THEM IN P31M OR P3M1 AND IN P6MM

GLIDES MAY BE ACCOMMODATED IN ONLY THESE TWO LOCATIONS, BUT THEY HAVE ALREADY APPEARED THERE IN P31M OR P3M1 AND IN BOTH POSITIONS FOR P6MM

ACCORDINGLY, THERE ARE NO NEW POSSIBILITIES FOR INTERLEAVING MIRROR PLANES OR GLIDES IN COMBINATION WITH A 3-FOLD OR 6-FOLD AXIS

THUS, OUT OF OUR CONSIDERATIONS OF POSSIBLE POSITIONS FOR NEW PLANE GROUPS INVOLVING m OR g INTERLEAVED WITH AXES HAVE COME 5 ADDITIONAL COMBINATIONS OF PLANES AND AXES — LABELED (A) THROUGH (E) ABOVE — WHICH MUST BE EXAMINED AS LEADING TO POTENTIALLY NEW PLANE GROUPS.

SEVERAL OF THESE (A, B & E) INVOLVE A COMBINATION OF SYMMETRY ELEMENTS WHICH WE HAVE NOT PREVIOUSLY CONSIDERED — NAMELY THE COMBINATION OF A ROTATION OPERATION WITH A PLANE WHICH DOES NOT PASS THROUGH THE AXIS. IN OTHER CASES (cg, C) WE HAVE A GLIDE RATHER THAN A m PASSING THROUGH THE ROTATION AXES. THESE COMBINATIONS WILL REQUIRE AN APPROPRIATE "COMBINATION THEOREM" TO BE ESTABLISHED BEFORE PROCEEDING FURTHER. THE NECESSARY THEOREMS MAY BE VIEWED AS GENERALIZATIONS OF THE THEOREM $m_1 \cdot A_n = m_2$ WHICH WAS DEVELOPED IN CONNECTION WITH DERIVATION OF THE POINT GROUPS.

LET US FIRST CONSIDER THE COMBINATION OF A_{π} WITH A MIRROR PLANE WHICH DOES NOT INTERSECT THE AXIS (BUT WHICH IS PARALLEL TO IT) BUT IS INSTEAD REMOVED FROM THE AXIS BY A DISTANCE δ .

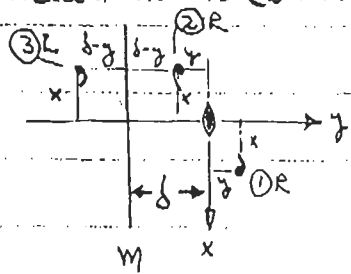

LET OBJECT (1) R, RIGHT-HANDED, SAY, BE ROTATED TO OBJECT (2) R BY THE OPERATION A_{π} . LET (2) R BE MAPPED TO (3) L BY REFLECTION IN A PLANE REMOVED FROM A_{π} BY A DISTANCE δ . NOW IS (1) R RELATED DIRECTLY TO (3) L? THEY ARE OF OPPOSITE HANDEDNESS AND MUST THEREFORE BE RELATED BY A MIRROR PLANE OR GLIDE. (1) & (3) ARE SYMMETRICALLY DISPOSED AT DISTANCE x ON EITHER SIDE OF THE y AXIS, BUT ARE TRANSLATED RELATIVE TO ONE ANOTHER IN THE y DIRECTION BY AN AMOUNT $y = y + (b-y) + (b-y) = 2\delta$. THE NEW OPERATION IS THUS A GLIDE WITH $A = 2\delta$ PASSING THROUGH THE 2-FOLD AXIS AND ORIENTED 90° TO THE ORIGINAL MIRROR PLANE

thus

$$M \cdot A_{\pi} = M'_{2\delta}$$

$\leftarrow \delta \rightarrow$

(AS MAY BE SEEN, ANY ATTEMPT TO NOTE THE MUTUAL ORIENTATION AND POSITION OF THE SYMMETRY ELEMENTS SYMMETRICALLY IS RAPIDLY BECOMING DIFFICULT)

LET'S NEXT CONSIDER A FURTHER GENERALIZATION OF THIS TYPE OF COMBINATION BY MAKING THE ORIGINAL PLANE A GLIDE

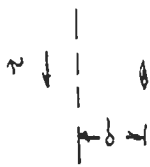

⇒ ?

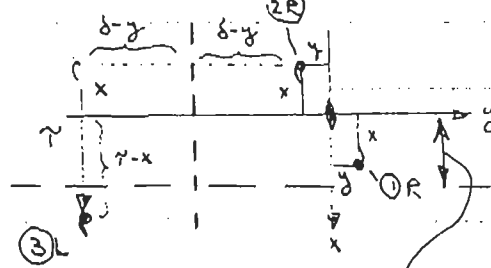

OBJECTS ① & ③ REMAIN, AS ABOVE, SEPARATED IN THE y DIRECTION BY AN AMOUNT $\tau = y + y + (\delta - y) + (\delta - y) = 2\delta$

THE OBJECTS ① & ③ ARE AGAIN SYMMETRICALLY DISPOSED ON EITHER SIDE OF A LINE RUNNING IN THE y DIRECTION, BUT THE LINE NO LONGER PASSES THROUGH

$$\frac{1}{2} [x + (x + 2\delta)] = \frac{1}{2} \tau$$

THE 2-FOLD AXIS: IT OCCURS AT A VALUE OF x WHICH IS THE AVERAGE OF THE x COORDINATES OF OBJECTS ① & ③, NAMELY $\frac{1}{2} [x + (x + 2\delta)] = \frac{1}{2} \tau$

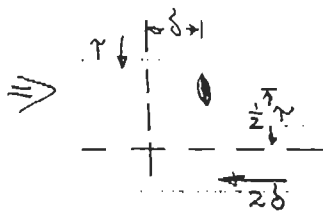
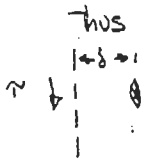

THUS A GLIDE WITH TRANSLATION COMPONENT τ COMBINED WITH A 2-FOLD AXIS PARALLEL TO IT, BUT SEPARATED BY A DISTANCE δ , CREATES A NEW GLIDE WITH TRANSLATION COMPONENT 2δ , AT RIGHT ANGLES TO THE INITIAL GLIDE AND REMOVED FROM THE 2-FOLD AXIS BY A DISTANCE $\frac{1}{2} \tau$

ANY ATTEMPT TO WRITE THIS RELATIONSHIP SYMBOLICALLY SHOULD NOT BE TAKEN SERIOUSLY, BUT LET'S TRY:

$$M_{\tau} \cdot A_{\pi} = M'_{2\delta} \cdot \frac{\pi}{2}$$

$\leftarrow \delta \rightarrow$

THE MORE FAMILIAR THEOREM

$$M \cdot A_{\pi} = M'$$

MAY BE SEEN TO BE A SPECIAL CASE OF THIS GENERAL RESULT IN WHICH $\delta = 0$ AND $\tau = 0$

(ONE FURTHER GENERALIZATION OF THIS THEOREM STILL REMAINS FOR 3 DIMENSIONS WHERE WE WILL ENCOUNTER SCREW AXES. WE COULD THEN REPLACE A_{π} WITH A 2-FOLD SCREW OPERATION)

COMBINATION OF A PLANE WITH A GENERAL ROTATION OPERATION

LET'S NOW CONSIDER THE CASE OF A PLANE (MIRROR) COMBINED WITH A GENERAL ROTATION OPERATION A_{α}

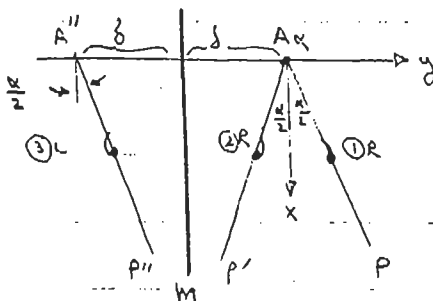

CONSTRUCT A LINE AP PASSING THROUGH THE ROTATION AXIS A AND MAKING AN ANGLE $\frac{\alpha}{2}$ RELATIVE TO THE MIRROR.

THE ROTATION OPERATION A_{α} MAPS AP INTO AP'

THE REFLECTION OPERATION MAPS AP' INTO A''P''

WE CAN GET DIRECTLY FROM AP TO A''P'' IN THE FOLLOWING TWO STEPS

- (a) TRANSLATE AP TO A''P'' BY AN AMOUNT 2δ IN THE y DIRECTION
- (b) REFLECT THINGS LEFT-TO-RIGHT ACROSS THE LINE A''P'' TO CHANGE HANDEDNESS

THESE TWO STEPS CONSIST OF REFLECTION AND TRANSLATION IN A DIRECTION INCLINED TO THE REFLECTION PLANE. LET US COMBINE THESE TWO STEPS INTO A SINGLE OPERATION USING A THEOREM WHICH WE HAD ESTABLISHED EARLIER:

$$M \cdot T = M'_{T_1} @ \frac{1}{2} T_1$$

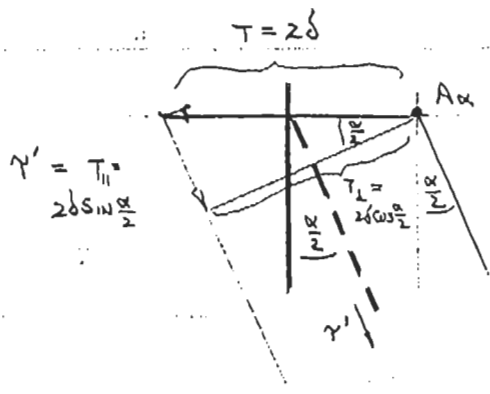

THE COMBINED MAPPING OF $A\alpha$ FOLLOWED BY REFLECTION IN A PLANE PARALLEL TO THE AXIS BUT REMOVED BY A DISTANCE δ IS THUS A GLIDE WITH TRANSLATION COMPONENT $\gamma' = 2\delta \sin \frac{\alpha}{2}$ INCLINED TO THE ORIGINAL MIRROR PLANE BY AN ANGLE $\frac{\alpha}{2}$ AND REMOVED FROM THE ROTATION AXIS BY A DISTANCE $\delta \cos \frac{\alpha}{2}$. THE NEW GLIDE INTERSECTS THE INITIAL MIRROR PLANE AT THE POINT WHERE A PERPENDICULAR BETWEEN THE AXIS AND m INTERSECTS THE MIRROR.

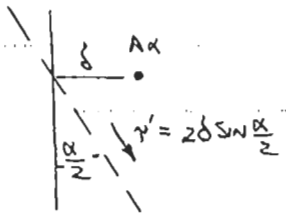
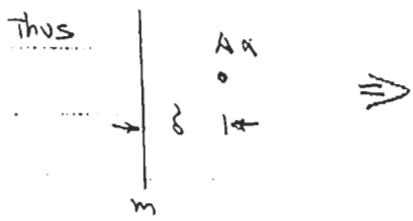

(CONVERSELY, COMBINING m WITH g AT ANGLE $\frac{\alpha}{2}$ CREATES A ROTATIONAL OPERATION $A\alpha$ AT A POINT REMOVED FROM THE LINE OF INTERSECTION OF THE TWO PLANES)

COMBINATION OF A GLIDE PLANE WITH A PARALLEL ROTATIONAL OPERATION AT A DISTANCE

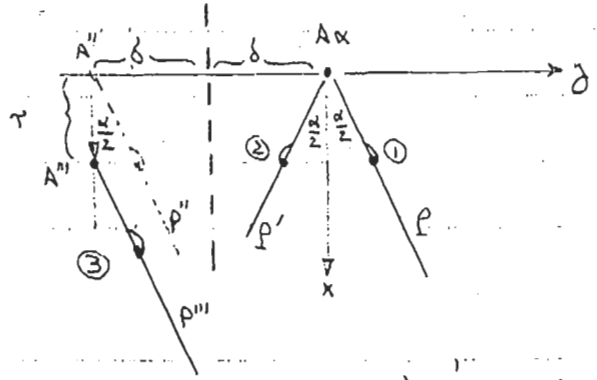

ROTATION OPERATION $A\alpha$ MAPS AP TO AP'
 THE GLIDE OPERATION REFLECTS AP' TO $A''P''$
 AND THEN TRANSLATES TO $A'''P'''$
 WE CAN MAP AP INTO $A'''P'''$ DIRECTLY BY TRANSLATING AP BY 2δ ALONG $-y$ AND γ ALONG x FOLLOWED BY REFLECTION ACROSS $A''P''$ TO CHANGE HANDEDNESS

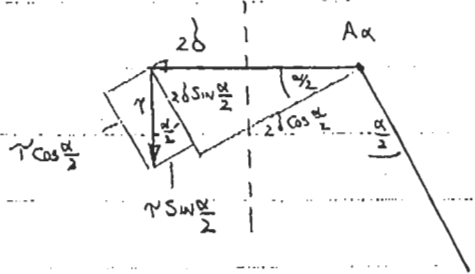

AGAIN $m \cdot T = m'_{T_{\perp}}$ @ $\frac{1}{2} T_{\perp}$
 HERE $T_{\perp} = 2\delta \cos \frac{\alpha}{2} + \gamma \sin \frac{\alpha}{2}$
 $T_{\parallel} = 2\delta \sin \frac{\alpha}{2} + \gamma \cos \frac{\alpha}{2}$

THE COMBINED EFFECT OF ROTATION THROUGH AN ANGLE α FOLLOWED BY GLIDE IN A PLANE REMOVED FROM THE AXIS BY A DISTANCE δ IS THUS GLIDE IN A NEW PLANE LOCATED $\frac{\alpha}{2}$ AWAY FROM THE FIRST, HAVING TRANSLATION COMPONENT $\gamma' = (2\delta \sin \frac{\alpha}{2} + \gamma \cos \frac{\alpha}{2})$ AND REMOVED FROM THE ROTATION AXIS BY A DISTANCE $\delta' = (\delta \sin \frac{\alpha}{2} + \frac{\gamma}{2} \cos \frac{\alpha}{2})$

WHERE DOES THIS NEW GLIDE INTERSECT THE FIRST? $\frac{1}{2}$ OF THE PERPENDICULAR COMPONENT OF THE TRANSLATION COMPONENT 2δ WOULD PLACE THE GLIDE AT THE INTERSECTION OF THE ORIGINAL GLIDE AND THE PERPENDICULAR TO $A\alpha$. ONE-HALF OF THE SECOND PART OF THE TRANSLATION, γ , SLIDES THE POINT OF INTERSECTION $\frac{1}{2}\gamma$ ALONG THE ORIGINAL GLIDE.

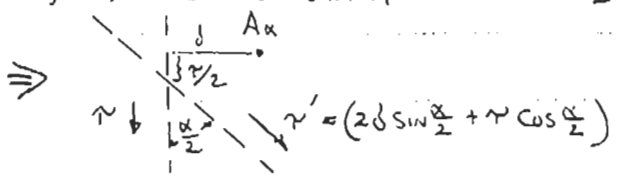
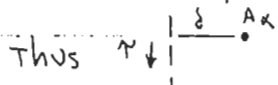

THIS MOST GENERAL THEOREM FOR TWO DIMENSIONS WILL ALSO NEED A FURTHER GENERALIZATION FOR THREE DIMENSIONS; REPLACEMENT OF \mathbb{N}_2 , A PURE ROTATION, BY A SCREW OPERATION.

BEFORE PROCEEDING TO COMPLETE OUR DERIVATION IT IS PERHAPS WORTH REPEATING, IN THE LANGUAGE OF GROUP THEORY. IN DERIVING THE POINT GROUPS, FOR EXAMPLE, WE TOOK A SUBGROUP... (A COMBINATION OF ROTATION AXES, FOR EXAMPLE) AND ADDED TO THIS GROUP OF OPERATIONS AN ADDITIONAL OPERATION (SUCH AS A HORIZONTAL MIRROR PLANE, FOR EXAMPLE) CALLED AN EXTENDER; FOR THE NEW COLLECTION OF OPERATIONS TO QUALIFY AS A GROUP, THE COMBINATION OF ANY TWO ELEMENTS ALSO HAS TO BE A MEMBER OF THE GROUP. IF A PARTICULAR COMBINATION OF ELEMENTS PROVIDES AN EFFECTIVE NET OPERATION WHICH IS NOT AN ELEMENT IN THE EXTENDED SET, WE ADD THE NEW OPERATION TO THE GROUP. WE CHECK THIS BY MEANS OF CONSTRUCTING THE "GROUP MULTIPLICATION TABLE"

WE ARE PERFORMING THE SAME OPERATION HERE, THE ONLY DIFFERENCE BEING THAT A PLANE GROUP IS AN INFINITE GROUP, RATHER THAN BEING A FINITE GROUP WITH A SMALL NUMBER OF ELEMENTS AS IS THE CASE WITH A POINT GROUP. TO A SUBGROUP (\mathbb{R}_2 , A PLANE GROUP SUCH AS $P2$) WE ADD A NEW EXTENDER OPERATION SUCH AS AN INTERLEAVED OR INTERSECTING REFLECTION OR GLIDE. WE THEN COMBINE THIS NEW OPERATION WITH THE OPERATIONS OF THE SUBGROUP (TRANSLATIONS TERMINATING WITHIN THE CELL; EXISTING ROTATION OPERATIONS IN THE SUBGROUP...) CONSTRUCTING, IN EFFECT, THE GROUP MULTIPLICATION TABLE. THE "COMBINATION THEOREMS" WE HAVE ESTABLISHED AS GENERAL RESULTS TELL US THE RESULT OF THE "PRODUCT" OF A GIVEN PAIR OF OPERATIONS. IF THE RESULT IS ALREADY A MEMBER OF THE GROUP (\mathbb{R}_2 , A MIRROR OPERATION WHICH FALLS ON TOP OF A MIRROR PLANE WHICH IS ALREADY IN THE PATTERN) WE DISCARD IT - IT IS NOTHING NEW; AN OPERATION WHICH IS ALREADY A MEMBER OF THE GROUP. IF THE RESULT IS A NEW OPERATION WHICH IS NOT ALREADY IN THE GROUP WE MUST ADD IT TO THE COLLECTION OF ELEMENTS WHICH CONSTITUTE THE GROUP.

RETURNING TO THE FIVE REMAINING POSSIBILITIES FOR COMBINING PLANES AND AXES (WHICH WE HAVE IDENTIFIED ON PG 12 & 13:

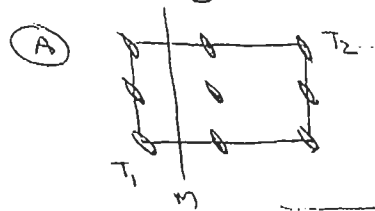

[WE WILL OMIT THE STEPS WHICH WE HAVE SEEN DO NOT LEAD TO NEW SYMMETRY ELEMENTS $\mathbb{R}_2 \cdot M \cdot T_1 = M' \equiv M'$ RIGHT ON TOP OF THE ORIGINAL M ; THUS NOTHING NEW]

THEOREM AT BOTTOM OF PG 13 FOR COMBINING AT WITH A M SEPARATED BY DISTANCE δ : $\gamma = \frac{1}{2}T_2$

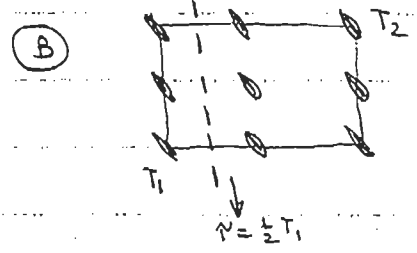
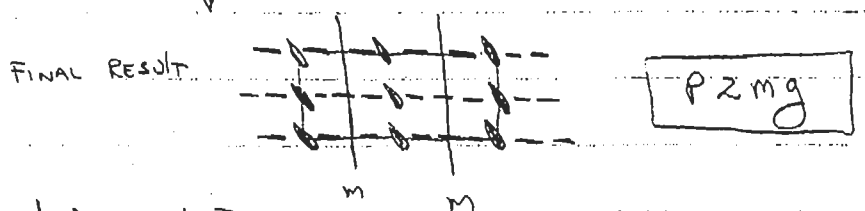
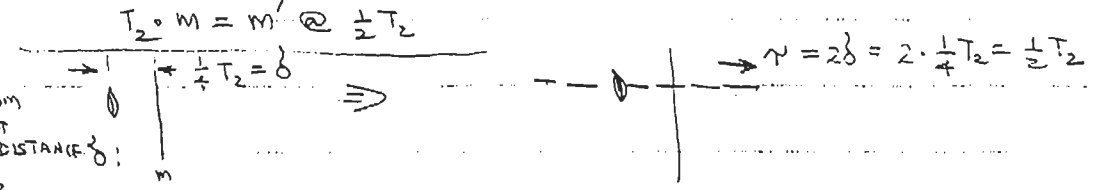

$T_2 \cdot M \cdot \frac{1}{2}T_1 = M' \cdot \frac{1}{2}T_1 @ \frac{1}{2}T_2$ from our INITIAL GLIDE - i.e., AT $\frac{3}{4}T_2$

THEOREM AT MIDDLE OF PG 14 PROVIDES

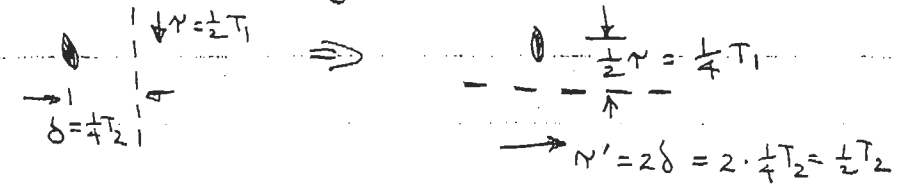

The new glide $\frac{1}{4}$ along T_1 with $\gamma = \frac{1}{2}T_2$ will be repeated again at $\frac{3}{4}T_1$

$(T_1 \cdot M_{\frac{1}{2}T_2} = M'_{\frac{1}{2}T_2} @ \frac{1}{2}T_1 \text{ from original glide at } \frac{1}{4}T_1)$

final result

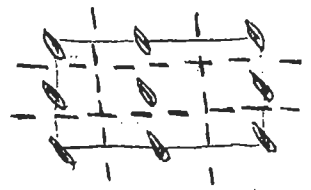

$P2gg$

TURNING NEXT TO THE THREE POSSIBILITIES (C) (D) & (E) ON THE TOP of Pg 13 for the SQUARE

NET

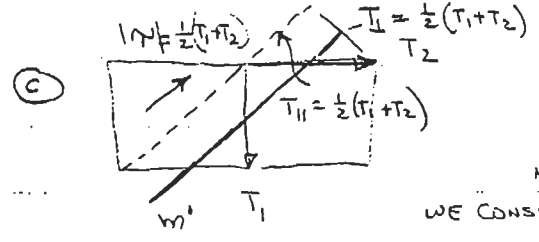

$T_2 \cdot M_{\frac{1}{2}(T_1+T_2)} = M'_{\frac{1}{2}(T_1+T_2)} @ \frac{1}{2} \cdot \frac{1}{2}(T_1+T_2)$

NOTE THAT THIS NEW MIRROR PLANE IS THE ONE WHICH WE CONSIDERED. ADDING INITIALLY IN POSSIBILITY (D)

(D) IN LIGHT OF THE ABOVE IT WOULD BE NOT AT ALL SURPRISING TO FIND THAT IF WE START BY ADDING THE MIRROR PLANE THROUGH THE 2-FOLD AXIS, WE GET A GLIDE PASSING THROUGH THE 4-FOLD AXIS

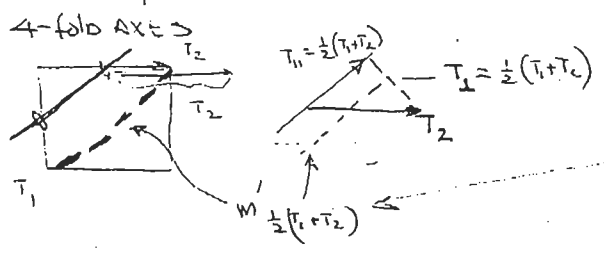

$T_2 \cdot M = M'_{\frac{1}{2}(T_1+T_2)} @ \frac{1}{2} \cdot \frac{1}{2}(T_1+T_2)$

BOTH (C) & (D) thus LEAD TO THE SAME RESULT. THE GLIDE & MIRROR PLANE, WHEN REPEATED BY THE 4-FOLD AXES GIVES FOR BOTH (C) & (D)

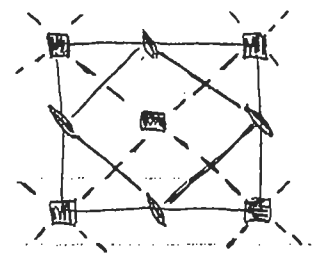

WE STILL HAVEN'T NOT CONSIDERED THE EFFECT OF COMBINING A 4-FOLD AXIS WITH A GLIDE PASSING THROUGH IT. USING THE THEOREM AT THE BOTTOM of Pg 15

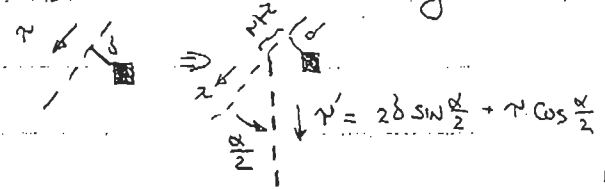

IN THE PRESENT CASE $\delta = 0$ so the new glide has

$\gamma' = 2 \cdot 0 \sin \frac{90^\circ}{2} + \gamma \cos \frac{90^\circ}{2}$
 $\gamma' = \gamma \cos 45^\circ = \frac{\gamma}{\sqrt{2}}$

BUT THE ORIGINAL γ IN THE FIRST GLIDE PLANE HAD MAGNITUDE $\frac{1}{2}|T_1+T_2| = \frac{1}{2}|T_1|\sqrt{2} = \gamma$

so $\gamma' = \frac{1}{2}|T_1|\sqrt{2} / \sqrt{2} = \frac{1}{2}T_1$

(C), (D) & (E) ALL thus LEAD TO THE SAME RESULT

$P4gm$

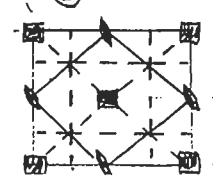

The result is ~~not~~ another glide, this one parallel to the cell edge. AND Golly, guess what?

This is precisely the third and final potential location for a glide, identified above as (E). If we started with this addition of a glide, the reverse of our present combination theorem would have fed back the glide along the diagonal of the cell.

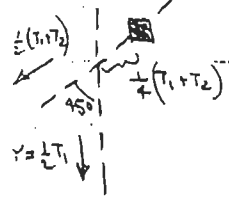

3.60 Symmetry, Structure and Tensor Properties of Materials

DISTRIBUTION OF LATTICE TYPES, POINT GROUPS AND PLANE GROUPS AMONG THE TWO-DIMENSIONAL CRYSTAL SYSTEMS

SYSTEM (4)	LATTICE (5)	POINT GROUP (10)	PLANE GROUPS (17)
OBLIQUE $a \neq b$ $\gamma \neq 90^\circ$	PRIMITIVE PARALLELOGRAM (oblique)	1	P1
		2	P2
RECTANGULAR $a \neq b$ $\gamma \equiv 90^\circ$	PRIMITIVE RECTANGLE CENTERED RECTANGLE (DIAMOND)	m	Pm P2g Cm
		2mm	P2mm P2mg P2gg C2mm
SQUARE $a_1 \equiv a_2$ $\gamma \equiv 90^\circ$	SQUARE	4	P4
		4mm	P4mm P4gm
HEXAGONAL $a_1 \equiv a_2$ $\gamma \equiv 120^\circ$	HEXAGONAL (EQUILATERAL)	3	P3
		3m	P3m1 P31m
		6	P6
		6mm	P6mm

3.60 SYMMETRY, STRUCTURE AND TENSOR PROPERTIES OF MATERIALS

NOTES ON SPHERICAL TRIGONOMETRY

SPHERICAL TRIGONOMETRY DIFFERS FROM EUCLIDIAN PLANE GEOMETRY IN THAT ALL OF THE ACTION TAKES PLACE ON THE SURFACE OF A SPHERE WHICH, FOR CONVENIENCE, WE CAN TAKE AS HAVING UNIT RADIUS.

A GREAT CIRCLE IS DEFINED AS THE CIRCLE OF INTERSECTION (UNIT RADIUS) OF THE SPHERE AND ANY PLANE PASSED THROUGH THE CENTER OF THE SPHERE.

A SMALL CIRCLE ($R < 1$) IS THE CIRCLE OF INTERSECTION WITH THE SPHERE OF ANY PLANE WHICH INTERSECTS THE SPHERE BUT DOES NOT PASS THROUGH ITS CENTER.

DISTANCE BETWEEN TWO POINTS

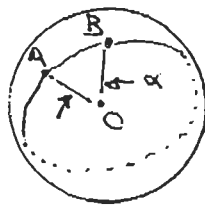

CONSIDER TWO POINTS $A \hat{ \in } B$ ON THE SURFACE OF THE SPHERE. THE "DISTANCE" BETWEEN $A \hat{ \in } B$ IS NOT THE LINE CONNECTING THEM (AS IN PLANE GEOMETRY) AS WE MUST REMAIN ON THE SURFACE OF THE SPHERE. POINTS $A \hat{ \in } B$ AND O , THE CENTER OF THE SPHERE, DEFINE A PLANE WHICH INTERSECTS THE SPHERE IN A GREAT CIRCLE. WE DEFINE THE DISTANCE BETWEEN $A \hat{ \in } B$ AS THE SHORTER OF THE TWO ARCS CONNECTING THE POINTS ALONG THE GREAT CIRCLE, AND MEASURE THE LENGTH \widehat{AB} IN TERMS OF THE ANGLE $\angle AOB = \alpha$ SUBTENDED BY THE ARC AT THE CENTER OF THE SPHERE. (NOTE THAT THIS DEFINITION MAKES LENGTHS INDEPENDENT OF THE RADIUS OF THE REFERENCE SPHERE. MOREOVER, AS "LENGTHS" ARE MEASURED IN ANGLES, ONE CAN SPEAK OF TRIGONOMETRIC FUNCTIONS OF LENGTHS, MIND-BOGGLING AS THIS MIGHT BE IN PLANE GEOMETRY)

POLE OF AN ARC OR OF A GREAT CIRCLE

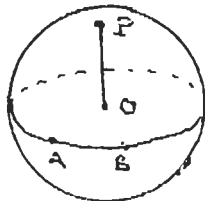

WE DEFINE AS THE POLE OF ARC \widehat{AB} THE POINT OF INTERSECTION WITH THE SPHERE OF A PERPENDICULAR LINE CONSTRUCTED AT THE CENTER OF THE SPHERE AND NORMAL TO THE PLANE OF THE GREAT CIRCLE WHICH DEFINES \widehat{AB} . (eg, THE EARTH'S NORTH POLE IS THE POLE OF THE EQUATOR)

A PROPERTY OF A POLE IS THAT IT IS A "DISTANCE" OF 90° AWAY FROM ANY POINT ON ARC \widehat{AB}

SPHERICAL TRIANGLES

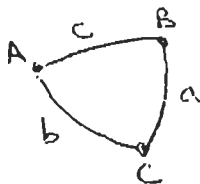

CONSIDER THREE POINTS $A, B \hat{ \in } C$ ON THE SURFACE OF THE SPHERE. A SPHERICAL TRIANGLE IS CONSTRUCTED FROM THEM BY PASSING GREAT CIRCLES THROUGH THESE POINTS TWO AT A TIME - i.e., BY CONSTRUCTING THE ARCS $\widehat{BC} = a$, $\widehat{AC} = b$, $\widehat{AB} = c$.

SPHERICAL ANGLES

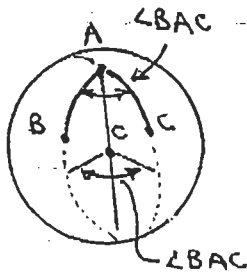

WE DEFINE, AS THE MEASURE OF THE SPHERICAL ANGLE $\angle BAC$ IN A SPHERICAL TRIANGLE, THE DIHEDRAL ANGLE BETWEEN THE PLANES WHICH DEFINE THE GREAT CIRCLES OF ARCS \widehat{BA} AND \widehat{AC} .

POLAR TRIANGLES

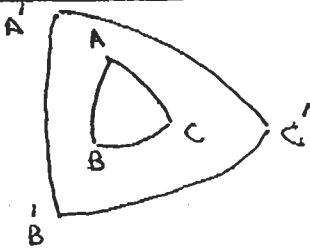

CONSIDER A SPHERICAL TRIANGLE ABC .

FIND A' , THE POLE OF ARC \widehat{BC}
 B' , THE POLE OF ARC \widehat{AC}
 C' , THE POLE OF ARC \widehat{AB} } NOW, CONNECT A', B', C' WITH ARCS OF GREAT CIRCLES.

TRIANGLE $A'B'C'$ IS SAID TO BE THE POLAR TRIANGLE OF TRIANGLE ABC

AN AMUSING FEATURE OF THESE TRIANGLES IS THAT THEY ARE MUTUALLY POLAR - THAT IS, IF $A'B'C'$ IS THE POLAR TRIANGLE OF ABC , THEN ABC IS ALSO THE POLAR TRIANGLE OF $A'B'C'$.

Proof: B' IS POLE OF \widehat{AC} , $\therefore B'$ IS 90° AWAY FROM ANY POINT ON \widehat{AC} , IN PARTICULAR POINT A .

C' IS POLE OF \widehat{AB} , $\therefore C'$ IS 90° AWAY FROM ANY POINT ON \widehat{AB} , IN PARTICULAR POINT A .

POINT A IS NOW ESTABLISHED AS 90° FROM B' , 90° FROM C' , THUS A MUST BE THE POLE OF $\widehat{B'C'}$. SIMILAR ARGUMENTS SHOW THAT B IS THE POLE OF $\widehat{A'C'}$, C IS THE POLE OF $\widehat{A'B'}$ QED.

IN TWO POLAR TRIANGLES THE ANGLE IN ONE IS THE SUPPLEMENT OF THE OPPOSITE SIDE

IN THE OTHER

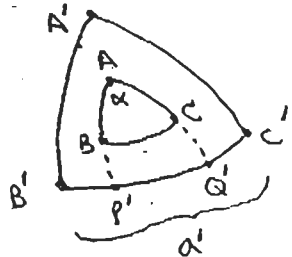

CONSIDER A PAIR OF POLAR TRIANGLES ABC AND $A'B'C'$

LET ANGLE $\angle BAC = \alpha$

SIDE $\widehat{B'C'} = \alpha'$

THIS THEOREM THEN STATES $\alpha' + \alpha = 180^\circ$.

Proof: EXTEND THE GREAT CIRCLES WHICH DEFINE \widehat{AB} AND \widehat{AC} UNTIL THEY INTERSECT $\widehat{B'C'}$ AT POINTS P' AND Q' , RESPECTIVELY.

B' IS POLE OF \widehat{AC} , $\therefore \widehat{B'Q'} = 90^\circ$

C' IS POLE OF \widehat{AB} , $\therefore \widehat{C'P'} = 90^\circ$

$$\begin{aligned} \text{THUS } \widehat{B'Q'} + \widehat{C'P'} &= 180^\circ = (\widehat{B'P'} + \widehat{P'Q'}) + (\widehat{P'Q'} + \widehat{Q'C'}) \\ &= (\widehat{B'P'} + \widehat{P'Q'} + \widehat{Q'C'}) + \widehat{P'Q'} = \alpha' + \widehat{P'Q'} \end{aligned}$$

BUT THE LENGTH OF $\widehat{P'Q'}$ IS NUMERICALLY EQUAL TO THE ANGLE USED TO MEASURE α (SEE DEFINITION OF SPHERICAL ANGLES, ABOVE)

$$\therefore \alpha' + \alpha = 180^\circ \quad \text{QED}$$

LAW of COSINES

IN PLANE GEOMETRY, THE LAW OF COSINES RELATES THE LENGTH OF ONE SIDE OF A TRIANGLE TO THE OTHER TWO SIDES AND THE ANGLE BETWEEN THEM. AN ANALOGOUS RELATION (GIVEN WITHOUT PROOF) EXISTS FOR SPHERICAL TRIANGLES.

PLANE GEOMETRY

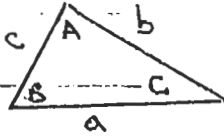

$$a^2 = b^2 + c^2 - 2bc \cos A$$

SPHERICAL GEOMETRY



$$\cos a = \cos b \cos c + \sin b \sin c \cos A$$

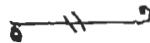

COMBINATION of TWO ROTATION OPERATIONS

LET US CONSIDER THE OPERATION WHICH ARISES WHEN TWO ROTATION OPERATIONS A_α AND B_β ARE COMBINED. FOR THE TIME BEING WE WILL CONSIDER ONLY COMBINATIONS OF SYMMETRY ELEMENTS WHICH PERTAIN TO A FINITE, CLOSED CLUSTER OF SYMMETRICALLY RELATED MOTIFS ABOUT SOME POINT IN SPACE. TO MEET THIS REQUIREMENT THE ROTATION AXES MUST INTERSECT AT A COMMON POINT. (OTHER ARRANGEMENTS OF MORE THAN ONE ROTATION OPERATION ARE POSSIBLE — FOR EXAMPLE, PLACING A 4-FOLD ROTATION AT EVERY LATTICE POINT OF A SQUARE NET — BUT THESE PERTAIN TO AN EXTENDED, INFINITE PATTERN)

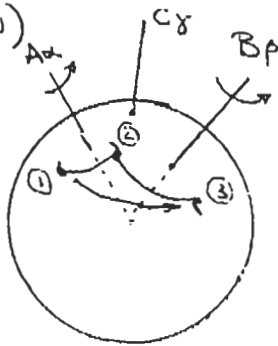

WE NOW ASK THE QUESTION $B_\beta \cdot A_\alpha = ?$

LET A_α AND B_β BE COMBINED AT SOME ANGLE c . THE ANSWER TO OUR QUESTION MAY BE OBTAINED BY EXAMINATION OF THE MOTION OF A MOTIF ON THE SURFACE OF A SPHERE. LET A SPHERE BE DRAWN ABOUT THE POINT OF INTERSECTION OF THE AXES. ROTATION A_α MOVES MOTIF ① TO ②. ROTATION B_β ACTING ON MOTIF ② MOVES IT TO ③. ALL THREE MOTIFS ARE OF THE SAME "HANDEDNESS" AS ROTATION DOES NOT PRODUCE AN ENANTIOMORPH.

WHAT OPERATION ARISES WHICH RELATES ① DIRECTLY TO ③? WE MAY ANSWER THE QUESTION BY THE PROCESS OF ELIMINATION. ONLY 4 OPERATIONS ARE POSSIBLE IN A 3-DIMENSIONAL SPACE: TRANSLATION, REFLECTION, ROTATION, AND INVERSION. REFLECTION AND INVERSION CHANGE "HANDEDNESS" AND WON'T DO THE JOB. TRANSLATION PRODUCES AN OBJECT OF THE SAME "HANDEDNESS", BUT MOTIFS ① AND ③ ARE NOT PARALLEL. MOREOVER, THE DISTANCE BETWEEN ① AND ③ DEPENDS ON EXACTLY WHERE THE INITIAL MOTIF IS PLACED RELATIVE TO A_x . TRANSLATION WON'T WORK EITHER. THEREFORE, BY ELIMINATION, THE THIRD OPERATION MUST BE A ROTATION:

$$B_\beta \cdot A_\alpha = C_\gamma$$

WE CAN FIND THE LOCATION OF AXIS C BY FINDING THE SMALL CIRCLE WHICH CONNECTS ① AND ③ AND PASSING A PERPENDICULAR THROUGH THE CENTER OF THE SPHERE. NOTE THAT IF THE SENSE OF ROTATION OF A_α AND B_β IS THE SAME, AXIS C_γ ALSO ACTS IN THE SAME DIRECTION.

TO ANSWER OUR QUESTION QUANTITATIVELY WE NEED TO KNOW THE MAGNITUDE OF γ AND ALSO THE ORIENTATION OF C RELATIVE TO THE FIRST TWO AXES. IN OTHER WORDS, FOR A_α AND B_β COMBINED AT A PARTICULAR ANGLE C WE WISH TO KNOW THE VALUES OF γ AND THE TWO REMAINING INTER-AXIAL ANGLES a AND b .

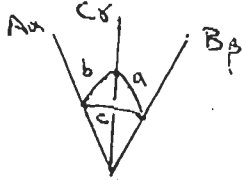

Clearly, the values of a , b and γ depend on the values selected for α , β and C .

CRYSTALLOGRAPHIC CONSTRAINTS

WE HAVE SHOWN THAT THE PATTERNS OF ATOMS IN CRYSTALS MUST, BY DEFINITION, BE TRANSLATIONALLY PERIODIC AND THAT ONLY 1-fold, 2-fold, 3-fold, 4-fold AND 6-fold ROTATION AXES MAY COEXIST WITH A TRANSLATION. ACCORDINGLY, IF WE RESTRICT OUR ATTENTION TO CRYSTALLOGRAPHIC ROTATION AXES, α & β CANNOT BE ANY OLD VALUES, BUT WILL BE RESTRICTED TO ^{VALUES OF} THE ANGULAR THROWS OF 1, 2, 3, 4 OR 6. THERE IS NOW A RATHER SEVERE CONSTRAINT ON THE ANGLE C AT WHICH A AND B ARE COMBINED: γ ALSO CANNOT BE ANY OLD VALUE. IT MUST BE A SUBMULTIPLE OF 2π AND, IF THE SYMMETRY IS TO BE COMPATIBLE WITH TRANSLATION, MUST ALSO TURN OUT TO BE THE ANGULAR THROW OF EITHER 1, 2, 3, 4 OR 6.

EULER'S CONSTRUCTION

IT IS NOT EXACTLY OBVIOUS HOW ONE OBTAINS a , b & γ IN TERMS OF α , β AND C . THE RELATIONSHIP MAY BE OBTAINED FROM A CONSTRUCTION DUE TO THE MATHEMATICIAN LEONHARD EULER (1707-1783).

① LOCATION OF THE AXIS C

CONSIDER THE POINTS A AND B WHERE AXES A_x AND B_β EMERGE FROM THE REFERENCE SPHERE. CONNECT A & B BY A GREAT CIRCLE. THE LENGTH OF THE ARC \widehat{AB} IS THUS EQUAL TO C , THE ANGLE AT WHICH A_x AND B_β ARE COMBINED.

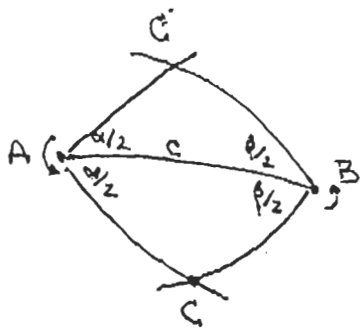

CONSTRUCT A GREAT CIRCLE THROUGH POINT A WHICH MAKES A SPHERICAL ANGLE $\alpha/2$ WITH \widehat{AB} (i.e., THE GREAT CIRCLE CONTAINING \widehat{AC} IN THE DIAGRAM TO THE LEFT) THE ACTION OF AXIS Ax ROTATES THIS GREAT CIRCLE THROUGH α TO A NEW LOCATION \widehat{AC}'

SIMILARLY, CONSTRUCT A GREAT CIRCLE THROUGH POINT B WHICH MAKES A SPHERICAL ANGLE $\beta/2$ WITH \widehat{AB} (i.e., THE GREAT CIRCLE CONTAINING \widehat{BC}) $B\beta$ ROTATES THIS GREAT CIRCLE THROUGH β TO A NEW LOCATION \widehat{BC}' .

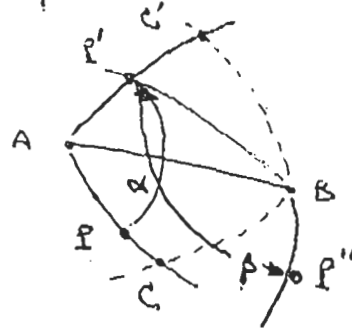

TO FIND THE LOCATION OF AXIS C WE NOW INVOLVE OUR DEFINITION OF A SYMMETRY ELEMENT: IT IS THE LOCUS OF POINTS LEFT UNMOVED BY AN OPERATION. If $C\gamma = B\beta \cdot A\alpha$, THE PLACE WHERE AXIS C EMERGES FROM THE SPHERE MUST BE THE POINT WHICH IS LEFT UNMOVED BY THE SUCCESSIVE ROTATIONS $A\alpha$ & $B\beta$. LET US EXAMINE THE POINTS ALONG GREAT CIRCLE \widehat{AC} WHICH SATISFY THIS CONDITION. IT OBVIOUSLY IS NOT FULFILLED BY MOST POINTS ALONG THIS LOCUS. (IN THE DIAGRAM ABOVE, FOR EXAMPLE, POINT P ON \widehat{AC} IS ROTATED TO LOCATION P' BY $A\alpha$. THE OPERATION $B\beta$ DOES NOT RESTORE P TO ITS ORIGINAL LOCATION, BUT INSTEAD MOVES IT TO A NEW LOCATION P'')

THE ONLY POINT IN OUR CONSTRUCTION WHICH IS RESTORED TO ITS ORIGINAL LOCATION BY THE SUCCESSIVE OPERATION OF $A\alpha$ AND $B\beta$ IS POINT C. THIS IS WHERE $C\gamma$ EMERGES FROM THE SPHERE. THE LENGTHS OF ARCS \widehat{AC} AND \widehat{BC} REPRESENT THE ANGLES WHICH THE NEW AXIS MAKES WITH RESPECT TO $A\alpha$ AND $B\beta$.

② THE VALUE OF γ

NEXT EXAMINE HOW A DIFFERENT POINT ON THE SPHERE IS MOVED. LET US CONSIDER POINT A.

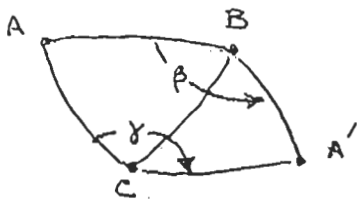

$A\alpha$ LEAVES POINT A UNMOVED, AS IT SITS SMACK ON THE AXIS Ax . $B\beta$ MOVES POINT A TO A NEW LOCATION A'.

CONNECT B & A' WITH GREAT CIRCLE \widehat{BA}' . CONNECT C & A' WITH GREAT CIRCLE \widehat{CA}' .

NOW, $B\beta \cdot A\alpha = C\gamma$ SO A MUST BE RELATED TO A' BY THE OPERATION $C\gamma$. IT THEREFORE FOLLOWS THAT SPHERICAL ANGLE

$$\angle ACA' = \gamma$$

NEXT EXAMINE SPHERICAL TRIANGLES BAC AND BA'C.

$$\angle ABC = \angle A'BC = \beta/2$$

$\widehat{AB} = \widehat{A'B}$ AS THEY ARE RELATED BY ROTATION
 \widehat{BC} IS COMMON TO THE TWO TRIANGLES

$\therefore \triangle ABC = \triangle A'BC$ AS THEY HAVE TWO SIDES AND AN INCLUDED ANGLE EQUAL

$$\therefore \angle ACB = \angle A'CB = \gamma/2$$

WE NOW HAVE ALL QUANTITIES OF INTEREST $\alpha/2$, $\beta/2$, $\gamma/2$ AND THE INTERAXIAL ANGLES a , b & c IN ONE SPHERICAL TRIANGLE.

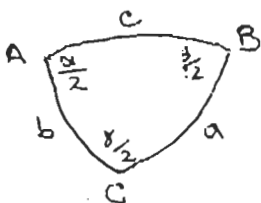

CAUTIONARY NOTE:

THE SPHERICAL ANGLES IN OUR FINAL TRIANGLE ARE HALF OF THE ANGULAR THROW OF THE ROTATION AXES AND NOT THE ROTATION ANGLES THEMSELVES.

QUANTITATIVE RELATION BETWEEN ANGLES



THE LAW OF COSINES WHEN APPLIED TO A SPHERICAL TRIANGLE WITH SIDES u, v, w AND ANGLES U, V, W PROVIDES

$$\cos w = \cos u \cos v + \sin u \sin v \cos W$$



APPLYING THIS TO THE SPHERICAL TRIANGLE OF EULER'S CONSTRUCTION YIELDS

$$\cos c = \cos a \cos b + \sin a \sin b \cos \frac{\gamma}{2}$$

WITH SIMILAR EQUATIONS FOR a & b . EACH IS A LOVELY EQUATION. UNFORTUNATELY, THEY INVOLVE THE PARAMETERS WHICH WE DO NOT KNOW — NAMELY, THE UNKNOWN INTERAXIAL ANGLES a & b — AND NOT THE VARIABLES WHICH WE MAY SELECT (THE CRYSTALLOGRAPHIC ROTATION ANGLES α, β & γ .)

WE CAN GET AROUND THIS PROBLEM BY CONSTRUCTING THE POLAR TRIANGLE OF $\triangle ABC$, AND MAKING USE OF THE FACT THAT AN ANGLE IN ONE TRIANGLE AND THE OPPOSITE SIDE IN THE OTHER ARE SUPPLEMENTS

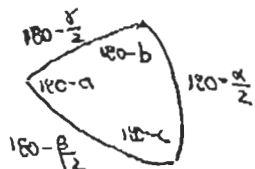

APPLYING THE LAW OF COSINES TO THE POLAR TRIANGLE PROVIDES

$$\cos(180 - \frac{\gamma}{2}) = \cos(180 - \frac{\alpha}{2}) \cos(180 - \frac{\beta}{2}) + \sin(180 - \frac{\alpha}{2}) \sin(180 - \frac{\beta}{2}) \cos(180 - c)$$

NOTING THAT $\cos(180 - \phi) = -\cos \phi$ AND $\sin(180 - \phi) = \sin \phi$

$$-\cos \frac{\gamma}{2} = \cos \frac{\alpha}{2} \cos \frac{\beta}{2} - \sin \frac{\alpha}{2} \sin \frac{\beta}{2} \cos c$$

SOVING FOR THE COSINE OF THE INTERAXIAL ANGLE c

$$\cos c = \frac{\cos \frac{\alpha}{2} \cos \frac{\beta}{2} + \cos \frac{\gamma}{2}}{\sin \frac{\alpha}{2} \sin \frac{\beta}{2}}$$

IF WE PICK AN AXIS A WITH ANGULAR THROW α , AND AN AXIS B WITH ANGULAR THROW β , THIS RELATION TELLS US THE ANGLE c AT WHICH THEY MUST BE COMBINED IN ORDER TO HAVE THE RESULTING THIRD AXIS C PRODUCE A DESIRED ANGLE OF ROTATION γ .

NOTE THAT WE HAVE NOT SPECIFIED THE COMBINATION OF AXES UNTIL WE FIND THE LOCATION OF THE AXIS C — THAT IS, WE STILL NEED VALUES FOR THE INTERAXIAL ANGLES a & b . THESE ARE, UPON FURTHER APPLICATION OF THE LAW OF COSINES:

$$\cos b = \frac{\cos \frac{\alpha}{2} \cos \frac{\gamma}{2} + \cos \frac{\beta}{2}}{\sin \frac{\alpha}{2} \sin \frac{\gamma}{2}}$$

$$\cos a = \frac{\cos \frac{\beta}{2} \cos \frac{\gamma}{2} + \cos \frac{\alpha}{2}}{\sin \frac{\beta}{2} \sin \frac{\gamma}{2}}$$

COMBINATIONS TO BE TESTED THE NUMBER OF COMBINATIONS OF CRYSTALLOGRAPHIC ROTATION AXES 1, 2, 3, 4 & 6, WITHOUT CONCERN FOR PERMUTATIONS, IS PROVIDED IN THE FOLLOWING TABLE

A \ B	1	2	3	4	6
1	111 112 113 114 116				
2	212 213 214 216	222 223 224 226			
3	313 314 316	323 324 326	333 334 336		
4	414 416	424 426	434 436	444 446	
6	616	626	636	646	666

35 COMBINATIONS ARE DISTINCT BUT, OF THESE, 4 OF THE TYPE 111 ARE IMPOSSIBLE AS NO ROTATION FOLLOWED BY NO ROTATION CANNOT BE EQUIVALENT TO A NET ROTATION. ONLY A LIMITED NUMBER OF THE REMAINDER WORK. THESE ARE:

- 222 322 422 622
233 432

3.60 Symmetry, Structure and Tensor Properties of Materials

DERIVATION OF THE 32 CRYSTALLOGRAPHIC POINT GROUPS (CRYSTAL CLASSES)

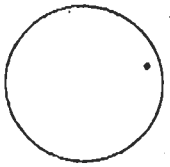
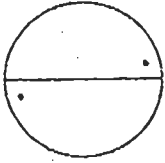
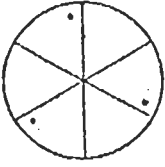
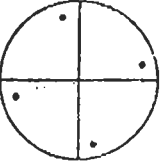
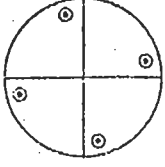
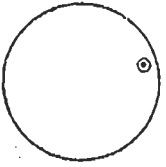
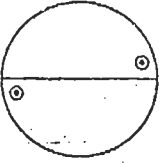
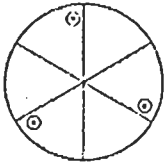
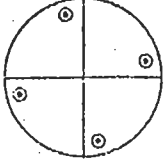
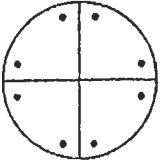
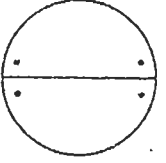
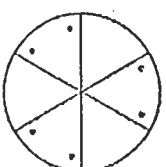
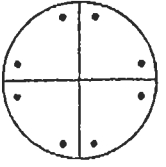
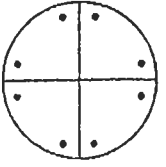
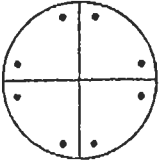
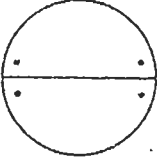
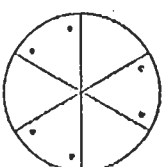
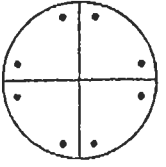
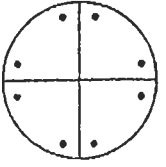
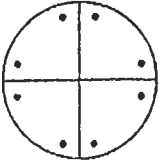
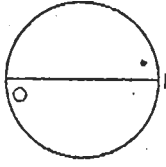
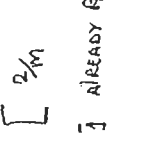
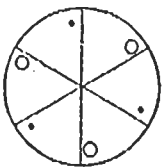
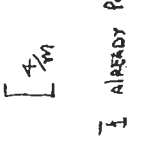
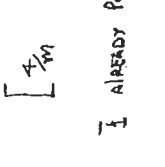
ARRANGEMENT of ROTATION AXES					
EXTENDER	 $1 \quad C_1$	 $2 \quad C_2$	 $3 \quad C_3$	 $4 \quad C_4$	 $4/m \quad C_{4h}$
HORIZONTAL MIRROR PLANE [$C_{nh} \quad D_{nh}$ $T_h \quad O_h$]	 $m(\bar{2}) \quad C_s$	 $2/m \quad C_{2h}$	 $3/m = \bar{6} \quad C_{3h}$	 $4/m \quad C_{4h}$	 $4/m \quad C_{4v}$
VERTICAL MIRROR PLANE [$C_{nv} \quad D_{nv}$ $T_v \quad O_v$]	 $mm2 \quad C_{2v}$	 $3m \quad C_{3v}$	 $4/m \quad C_{4v}$	 $4/m \quad C_{4v}$	 $4/m \quad C_{4v}$
DIAGONAL MIRROR PLANE [$C_{nd} \quad D_{nd}$ $T_d \quad O_d$]	 $mm2 \quad C_{2v}$	 $3m \quad C_{3v}$	 $4/m \quad C_{4v}$	 $4/m \quad C_{4v}$	 $4/m \quad C_{4v}$
INVERSION CENTER [$C_{ni} \quad D_{ni}$ $T_i \quad O_i$]	 $1 \quad C_i$	 $2/m \quad C_{2h}$	 $3 \quad C_{3h}$	 $4/m \quad C_{4h}$	 $4/m \quad C_{4h}$

[$2/m \quad C_{2h}$]
ALREADY PRESENT IN $2/m$

[$4/m \quad C_{4h}$]
ALREADY PRESENT IN $4/m$

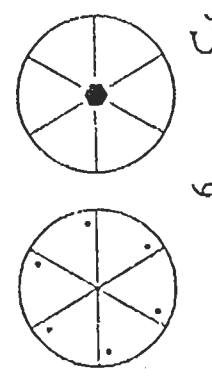
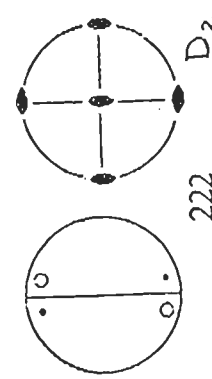
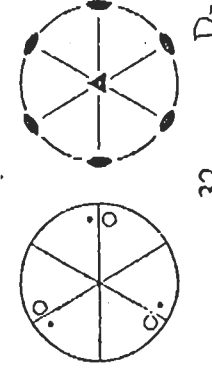
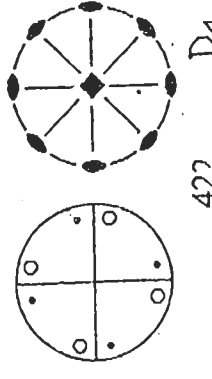
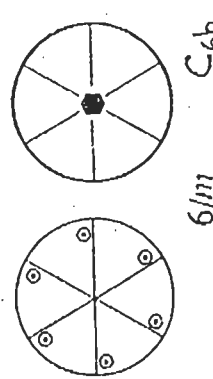
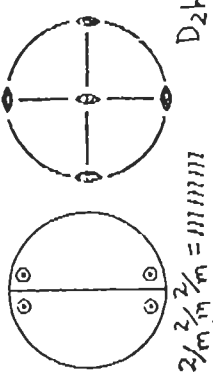
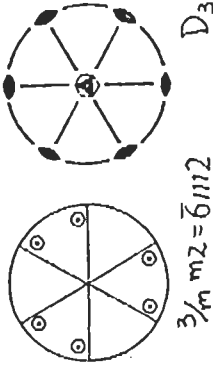
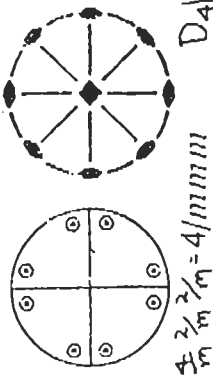
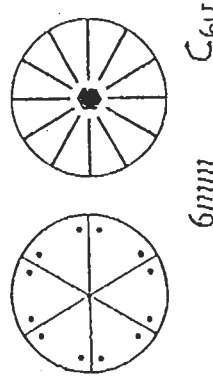
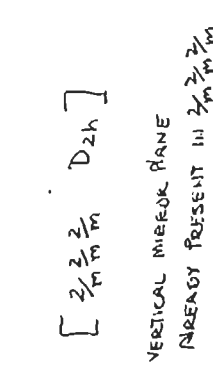
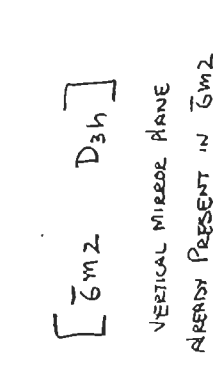
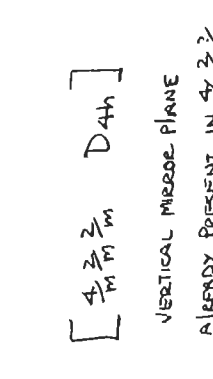
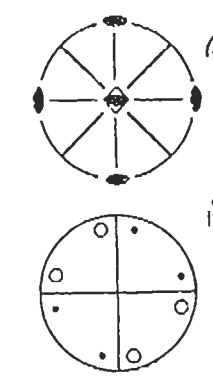
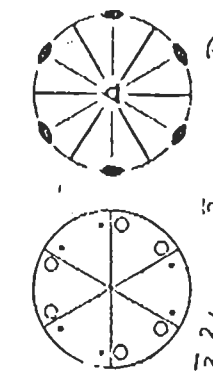
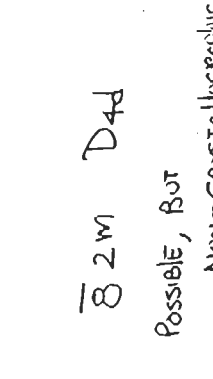
<p>ARRANGEMENT of ROTATION AXES</p> <p>EXTENDER</p>	 <p>6 C₆</p> <p>6/m C_{6h}</p>	 <p>222 D₂</p> <p>2/m 2/m 2/m = mmm D_{2h}</p>	 <p>32 D₃</p> <p>3/m 2/m = 6mm D_{3h}</p>	 <p>422 D₄</p> <p>4/m 2/m 2/m = 4/mmm D_{4h}</p>	<p>HORIZONTAL MIRROR PLANE</p>	 <p>6/m C_{6h}</p> <p>6mm C_{6v}</p>	 <p>[2/m 2/m 2/m D_{2h}]</p> <p>VERTICAL MIRROR PLANE ALREADY PRESENT IN 2/m 2/m 2/m</p>	 <p>[6m 2 D_{3h}]</p> <p>VERTICAL MIRROR PLANE ALREADY PRESENT IN 6m 2</p>	 <p>[4/m 2/m 2/m D_{4h}]</p> <p>VERTICAL MIRROR PLANE ALREADY PRESENT IN 4/m 2/m 2/m</p>	<p>VERTICAL MIRROR PLANE</p>	 <p>6mm C_{6v}</p> <p>6/m C_{6h}</p>	 <p>[2/m 2/m 2/m D_{2d}]</p> <p>VERTICAL MIRROR PLANE ALREADY PRESENT IN 2/m 2/m 2/m</p>	 <p>[3 2/m D_{3d}]</p> <p>VERTICAL MIRROR PLANE ALREADY PRESENT IN 3 2/m</p>	 <p>[8 2/m D_{4d}]</p> <p>VERTICAL MIRROR PLANE ALREADY PRESENT IN 8 2/m</p>	<p>DIAGONAL MIRROR PLANE</p>	<p>—</p>	 <p>[3 2/m D_{3d}]</p> <p>DIAGONAL MIRROR PLANE ALREADY PRESENT IN 3 2/m</p>	 <p>[3 2/m D_{3d}]</p> <p>DIAGONAL MIRROR PLANE ALREADY PRESENT IN 3 2/m</p>	 <p>[8 2/m D_{4d}]</p> <p>DIAGONAL MIRROR PLANE ALREADY PRESENT IN 8 2/m</p>	<p>INVERSION CENTER</p>	<p>[6/m C_{6h}]</p> <p>I ALREADY PRESENT IN 6/m</p>	<p>[2/m 2/m 2/m D_{2h}]</p> <p>INVERSION CENTER ALREADY PRESENT IN 2/m 2/m 2/m</p>	<p>[3 2/m D_{3d}]</p> <p>INVERSION CENTER ALREADY PRESENT IN 3 2/m</p>	<p>[4/m 2/m 2/m D_{4h}]</p> <p>INVERSION CENTER ALREADY PRESENT IN 4/m 2/m 2/m</p>
---	--	---	---	---	--	---	--	---	--	--------------------------------------	---	--	---	--	--------------------------------------	----------	--	---	--	-----------------------------	---	--	--	--

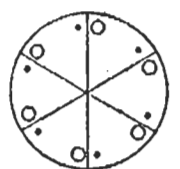
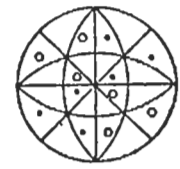
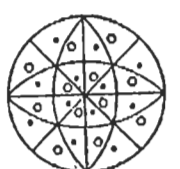
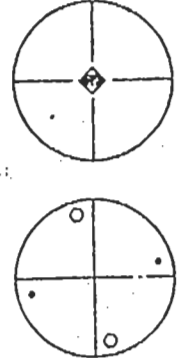
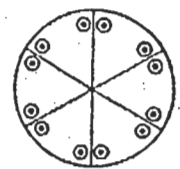
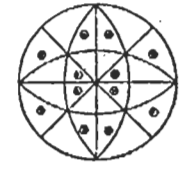
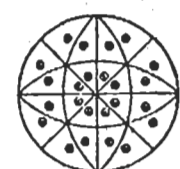
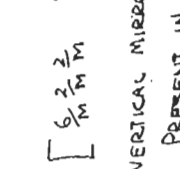
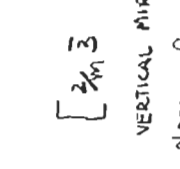
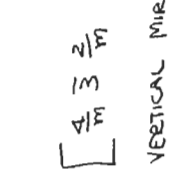
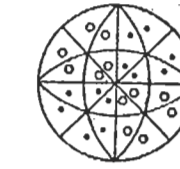
<p>ARRANGEMENT of ROTATION AXES</p> <p>EXTENDER</p>	 <p>622 D_6</p>	 <p>23 T</p>	 <p>432 O_h</p>	 <p>S_4</p>
<p>HORIZONTAL MIRROR PLANE</p>	 <p>$\frac{6}{m} \frac{2}{m} \frac{2}{m} = 6/mmm$ D_{6h}</p>	 <p>$\frac{2}{m} \bar{3} = m\bar{3}$ T_h</p>	 <p>$\frac{4}{m} \bar{3} \frac{2}{m} = m\bar{3}m$ O_h</p>	<p>$[\frac{4}{m} C_{4h}]$</p>
<p>VERTICAL MIRROR PLANE</p>	 <p>$[\frac{6}{m} \frac{2}{m} \frac{2}{m} D_{6h}]$ VERTICAL MIRROR PLANE ALREADY PRESENT IN $\frac{6}{m} \frac{2}{m} \frac{2}{m}$</p>	 <p>$[\frac{2}{m} \bar{3} T_h]$ VERTICAL MIRROR PLANE IS ALREADY PRESENT IN $\frac{2}{m} \bar{3}$</p>	 <p>$[\frac{4}{m} \bar{3} \frac{2}{m} O_h]$ VERTICAL MIRROR PLANE ALREADY PRESENT IN $\frac{4}{m} \bar{3} \frac{2}{m}$</p>	<p>$[\frac{4}{m} D_{2d}]$</p>
<p>DIAGONAL MIRROR PLANE</p>	<p>$\bar{2} 2 m D_{6d}$ POSSIBLE AND DISTINCT, BUT NON-CRYSTALLOGRAPHIC</p>	 <p>43m T_d</p>	<p>— IMPOSSIBLE ADJACENT ROTATION AXES ARE NOT THE SAME</p>	<p>—</p>
<p>INVERSION CENTER</p>	<p>$[\frac{6}{m} \frac{2}{m} \frac{2}{m} D_{6h}]$ INVERSION CENTER ALREADY PRESENT IN $\frac{6}{m} \frac{2}{m} \frac{2}{m}$</p>	<p>$[\frac{2}{m} \bar{3} T_h]$ INVERSION CENTER IS ALREADY PRESENT IN $\frac{2}{m} \bar{3}$</p>	<p>$[\frac{4}{m} \bar{3} \frac{2}{m} O_h]$ INVERSION CENTER IS ALREADY PRESENT IN $\frac{4}{m} \bar{3} \frac{2}{m}$</p>	<p>$[\frac{4}{m} C_{4h}]$</p>

3.60 Symmetry, Structure and Tensor Properties of Materials

DEMONSTRATION THAT, IN POINT GROUP 23, THERE IS ONLY ONE INDEPENDENT 2-FOLD AXIS AND ONE INDEPENDENT 3-FOLD AXIS — THAT IS, IF ONE LETS THIS PAIR OF ROTATIONAL SYMMETRIES REPEAT EACH OTHER, ONE OBTAINS ALL OF THE REMAINING AXES.

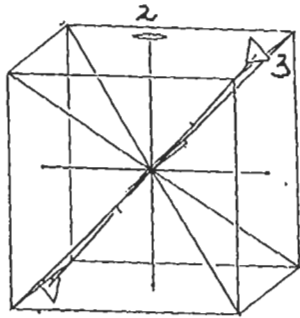

BEGIN WITH ONE 2-FOLD AXIS ALONG A FACE NORMAL AND ONE 3-FOLD ALONG A BODY DIAGONAL

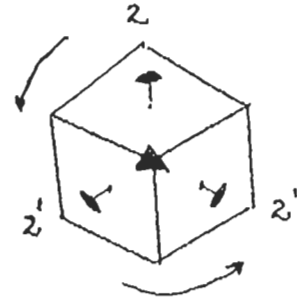

A CUBE WHEN VIEWED DIRECTLY ALONG ONE OF ITS BODY DIAGONALS LOOK LIKE THE ABOVE. ACTION OF THE 3-FOLD AXIS THEREFORE REPEATS 2 TO 2' AND 2''

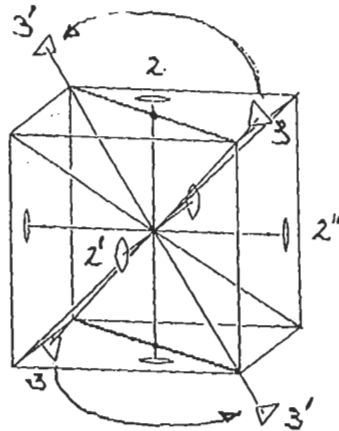

2 REPEATS 3 TO 3''

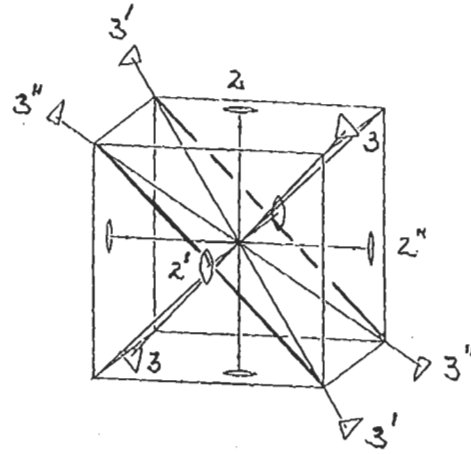

2' REPEATS 3' TO 3''

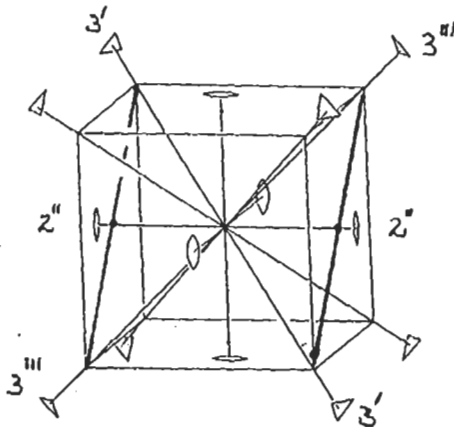

2'' REPEATS 3' TO 3'''

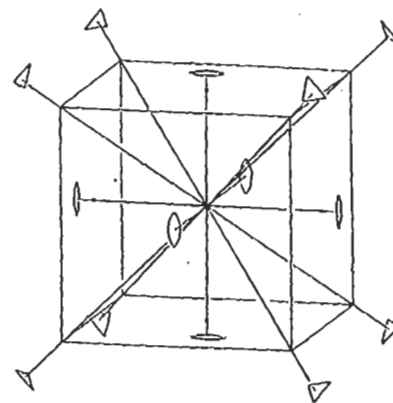

RESULT: STARTING WITH JUST ONE 2-FOLD AXIS AND A SINGLE 3-FOLD AXIS WE FINISH WITH A 2-FOLD ALONG EACH FACE-NORMAL AND A 3-FOLD AXIS ALONG EVERY BODY DIAGONAL

3.60 Symmetry, Structure and Tensor Properties of Materials

Summary of the 2-Dimensional Plane Groups in Preparation for Addition of a Stacking Vector to Produce a Space Lattice.

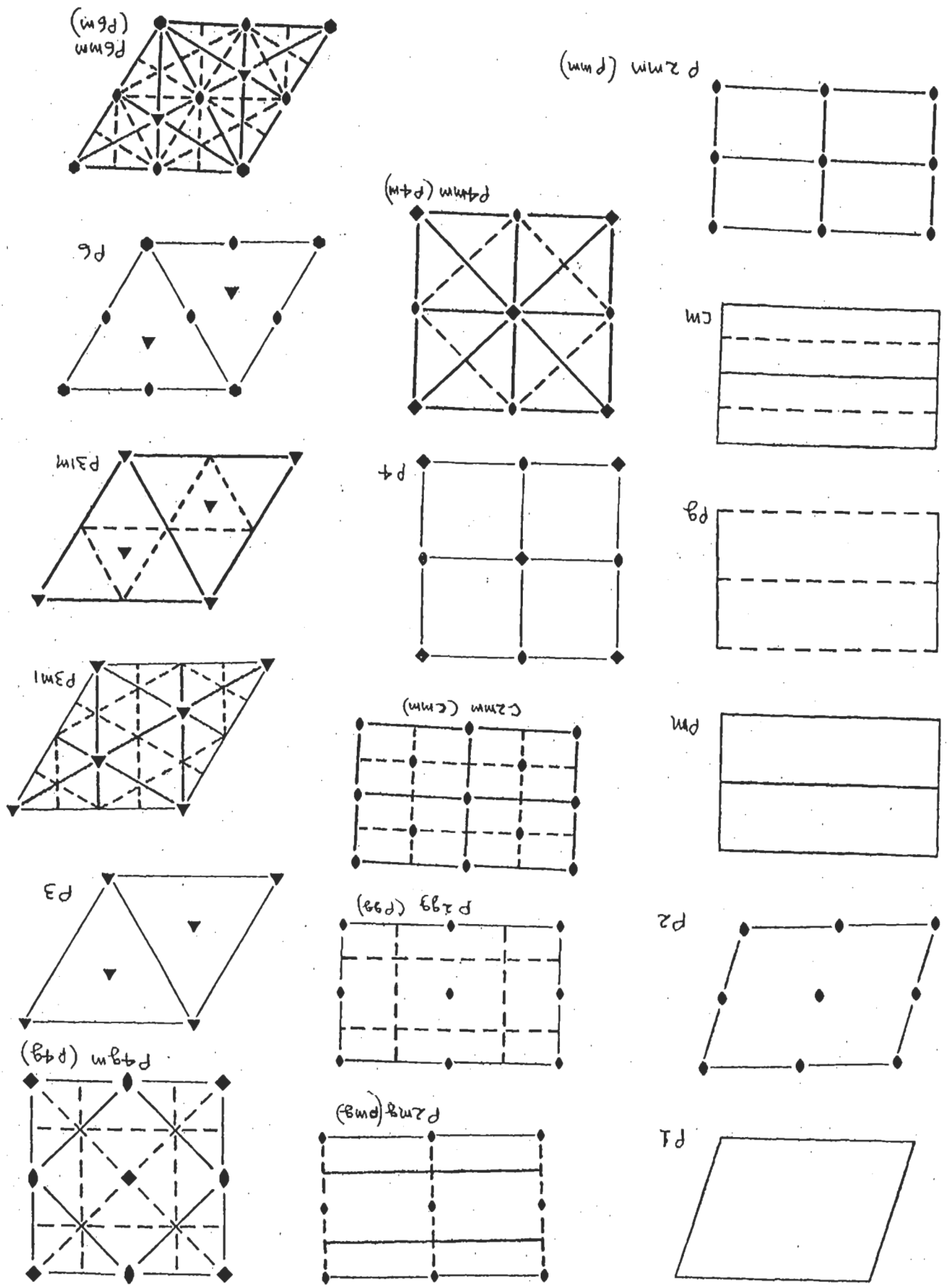

3.60 Symmetry, Structure and Tensor Properties of Materials

DERIVATION OF THE SPACE LATTICES

The point group of a crystal imposes constraints on the lattices with which it may be combined. Specification of a third translation, T_3 , which is not coplanar with the pair of conjugate translations T_1 and T_2 which generate a plane net, will define a space lattice. We have seen that the two-dimensional crystallographic point groups (1 2 3 4 6 m 2mm 3m 4mm 6mm) require 5 distinct two-dimensional nets (parallelogram, rectangular, centered-rectangular, square, hexagonal) with which they may be combined to provide 17 two-dimensional plane groups.

Each of the 5 two-dimensional nets provides a potential base with a distinct "specialness" for a space lattice. However, this "specialness" is present if, and only if, there is symmetry present which requires this "specialness". In a three-dimensional lattice this symmetry cannot be confined just to the two-dimensional base of the cell; it extends through all of space. The constraint imposed on the choice of T_3 to be combined with a two-dimensional net is accordingly, that symmetry elements present in the plane group which requires specialization of the base of the cell must coincide in subsequent layers of the space lattice. For example, if we pick an arbitrary T_3 in combination with plane group P_2 , the symmetry of the plane group in the base of the cell is destroyed, and translational periodicity which is incompatible with that of the base is also created.

(The text derives the space lattices by stacking plane nets containing only the rotation axes. Although this leads to the correct results, this procedure is incomplete--all 17 plane groups should be considered. Moreover, the procedure is not rigorous. For example, a two-fold axis by itself in a rectangular net does not require the net to be rectangular: a two-fold axis in a centered-rectangular net permits a choice for T_3 which is impossible when the full plane system is considered.)

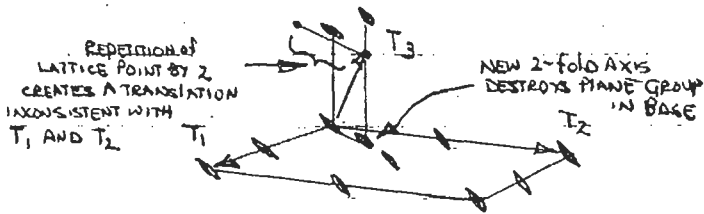

In the following derivation we specify T_3 in terms of 3 components: x (a fraction of T_1), y (a fraction of T_2) and a component z in a direction normal to the plane of the plane group. The possible terminal points of T_3 which make symmetry elements line up are circled in the diagrams. These locations are the independent locations which have the same point group as the origin of the cell.

Point Group 1

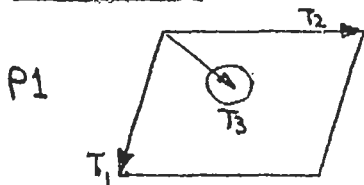

T_3 : xyz Triclinic Primitive

Point Group 2

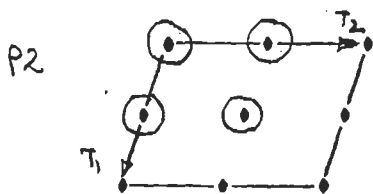

- T₃: 00z Monoclinic Primitive
- ½0z or 0½z Monoclinic Side-Centered
- ½½z Monoclinic Body-Centered

(Monoclinic side-centered and monoclinic body-centered are not distinct specializations. One may be converted into the other by appropriate redefinition of the parallelogram base, with no loss of specialness.)

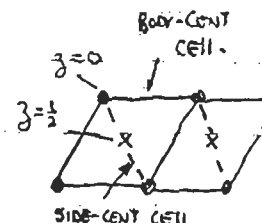

Point Group m

pm

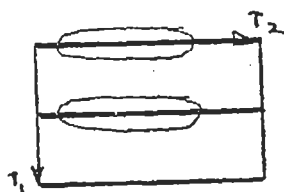

pg

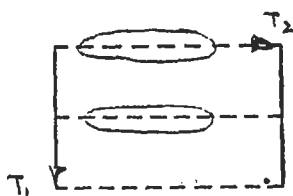

oyz Monoclinic Primitive

(As above, except here "base" of cell is one of the rectangular faces; parallelogram face contains T₂ and T₃)

½yz Monoclinic Body-Centered
(or side-centered)

Point Group m

cm

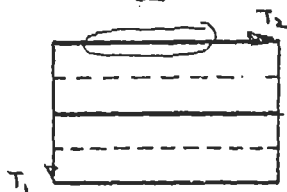

oyz Monoclinic Side-Centered

(Note that ½yz is no longer distinct--a lattice point exists on both the mirror plane at x = 0 and the mirror plane at x = ½. The mirror planes are not independent as in pm.)

Point Group 2mm

P2mm

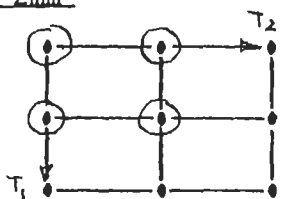

ooz Orthorhombic Primitive

½oz and 0½z Orthorhombic Side-Centered

½½z Orthorhombic Body-Centered

P2mg

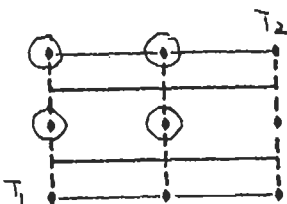

(Note that here, unlike the monoclinic system, both the side-centered and the body-centered lattices are distinct. One cannot transform one into the other without degrading the rectangular base to a parallelogram and losing specialization.)

P2gg

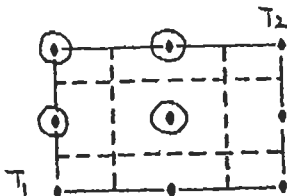

Point Group 2mm

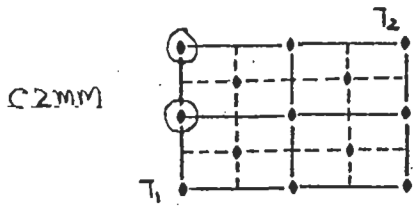

$00z$ Orthorhombic Primitive (Note that $\frac{1}{2}z$ is now the same as this choice: lattice points exist in the base at both 00 and $\frac{1}{2}z$. Both lead to lattice points directly over one another in subsequent nets in the stack.)

$\frac{1}{2}z$ Orthorhombic Face-Centered (Note that $0\frac{1}{2}z$ is now equivalent to this choice. Both are points of $2mm$ symmetry displaced from a lattice point by $\frac{1}{2}T_1$.)

Point Groups 4 and 4mm

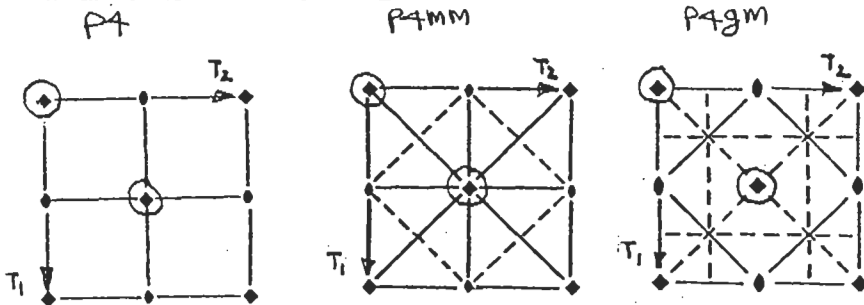

$00z$ Tetragonal Primitive

$\frac{1}{2}z$ Tetragonal Body-Centered

Point Groups 3 and 3m

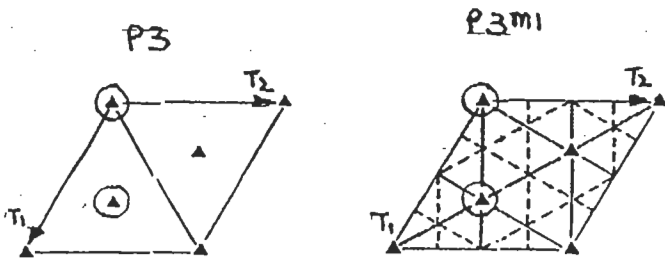

$00z$ Hexagonal Primitive

$\frac{2}{3}z$ Hexagonal Rhombohedral

(Note: the third 3-fold axis at $\frac{1}{3}z$ is an independent symmetry element in this case, but the choice of $\frac{1}{3}z$ for T_3 does not lead to a distinct lattice. Upon rotating the lattices to the left by 180° this choice will be seen to give the same result.)

Point Groups 3m (alternate setting), 6 and 6mm

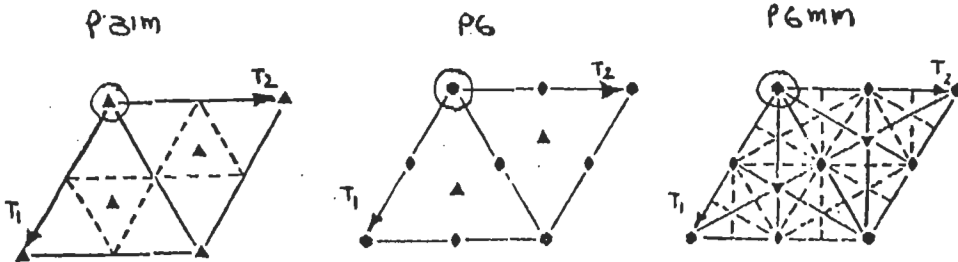

$00z$ Hexagonal Primitive

(Note that the choice of $\frac{1}{3}z$ or $\frac{2}{3}z$ is here impossible. Different symmetry exists at these locations than at the origin.)

The stackings of the 17 plane groups considered above have provided 11 distinct space lattices (it is amusing to note, also, that by so doing we have obtained 32 of the 230 three-dimensional space groups). These are the space lattices required by only 10 of the 32 three-dimensional point groups (namely, those which are also two-dimensional in nature).

We next examine the additional requirements, if any, imposed on space lattices by the remaining 32-10=22 point groups.

1. The requirements of point groups C_n (1, 2, 3, 4, 6) and C_{nv} ($2mm$, $3m$, $4mm$ and $6mm$) have been obtained above by stacking the plane groups.

2. Requirements of $\bar{1}$: The presence of $\bar{1}$ in a lattice requires that for every translation \vec{T} a translation $-\vec{T}$ must exist. This is true of any lattice, so $\bar{1}$ requires only the general triclinic primitive lattice.

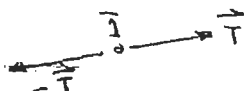

*The fact that inversion imposes no restriction on a lattice now permits us to use symmetry arguments to shorten the list of point groups which need to be considered further. If inversion imposes no restriction, then any point groups which become the same upon addition of inversion must require the same constraints of the lattice.

e.g.: $2 + \bar{1} = 2/m$. $\bar{1}$ imposes no constraint, so lattices required by $2/m$ must be identical to those required by 2. (i.e., monoclinic)

Therefore, in deriving the remaining space lattices we need to consider the requirements of the 11 Laue Groups--or, better yet, any simpler representative point group in the collection which becomes the Laue Group upon the addition of inversion.

e.g.: 222 , $2mm$ and $2/m\ 2/m\ 2/m$ all become the Laue Group $2/m\ 2/m\ 2/m$ upon addition of $\bar{1}$. Therefore all require the same lattice types. Rather than consider the higher symmetry of the Laue Group itself, we can instead work with a simpler symmetry such as 222 or $2mm$.

Point Groups Already Considered by Stacking Plane Groups	Resulting Lattice Types	Other Point Groups Which Correspond to the Same Laue Group
1	Triclinic Primitive	$\bar{1}$
$2, m$	Monoclinic Primitive Monoclinic { Side-Centered Body-Centered	$2/m$
$2mm$	Orthorhombic Primitive Side-Centered Body-Centered Face-Centered	$222, 2/m\ 2/m\ 2/m$

Point Groups Already Considered by Stacking Plane Groups	Resulting Lattice Types	Other Point Groups Which Correspond to the Same Laue Group
4 4mm	Tetragonal Primitive Body-Centered	$\bar{4}$, 4/m 422, $\bar{4}2m$, 4/m 2/m 2/m
3 3m1	Hexagonal Primitive or Rhombohedral	$\bar{3}$ 312, $\bar{3} 2/m$
31m 6 6mm	Hexagonal Primitive	321, $\bar{3} 2/m$ 3/m, 6/m 622, $\bar{6} 2/m, 6/m 2/m 2/m$

Using this neat device, one sees that the requirements of all remaining 32 - 10 = 22 point groups have been treated with the exception of the cubic point groups.

If you do not like this shortcut, one can deal with the point groups in the right-hand column on a case-by-case basis.

Example: Point group 4 requires tetragonal primitive or body-centered. 4/m has an additional horizontal m. m requires that a rectangular (or centered rectangular) net be normal to it. This is automatically satisfied by the rectangular sides of the tetragonal lattices.

422 has additional two-fold axes normal to 4. 2 requires only that a parallelogram net be normal to it. The requirements of 2 are thus satisfied if we orient 422 in the tetragonal cells such that the two-fold axes are normal to the rectangular sides of the cell. (The two-fold axes 45° away from the sides of the cell find themselves normal to (110), which is also a rectangular net, and thus are also perfectly happy.) Thus 422 may be accommodated in either of the two tetragonal cells.

Requirements of Cubic Point Groups

Laue Group: 4/m $\bar{3}$ 2/m corresponding point groups: ~~432~~, $\bar{4}3m$, 4/m $\bar{3}$ 2/m
 Laue Group: 2/m $\bar{3}$ corresponding point groups: ~~23~~, 2/m $\bar{3}$

Consider, for simplicity, the two simplest axial arrangements. The others must have the same requirements.

Point Group 23

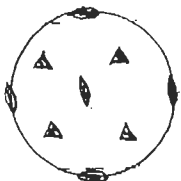

Start with the three orthogonal two-fold axes. This requires, at minimum, one of the orthogonal brick-shaped orthorhombic cells of 222.

- i.e., Primitive
- Side-Centered
- Body-Centered
- Face-Centered

The three-fold axes must be oriented along the body-diagonals and, by rotation, require that the three cell edges be equal.

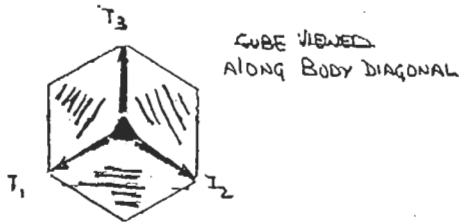

This leads to Primitive Cubic
Body-Centered Cubic
Face-Centered Cubic

(The side-centered orthorhombic cell also leads to the face-centered cubic lattice as the three-fold axis requires that all faces of the cube be equivalent. Each must accordingly bear a centered lattice point.)

Point Group 432

Start with the tetragonal primitive and body-centered cells which, at minimum, are required by one four-fold axis.

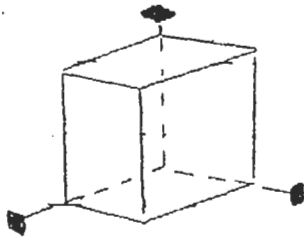

The two additional orthogonal four-fold axes now require that all faces of the cell be square and, as above, the three-fold axis requires that all edges and faces be equivalent. The tetragonal P and I lattices thus become

Primitive Cubic
Body-Centered Cubic

At first glance it appears as though 432 does not require a face-centered cubic lattice. There is, however, an alternate setting possible for 432 relative to the tetragonal lattices considered above.

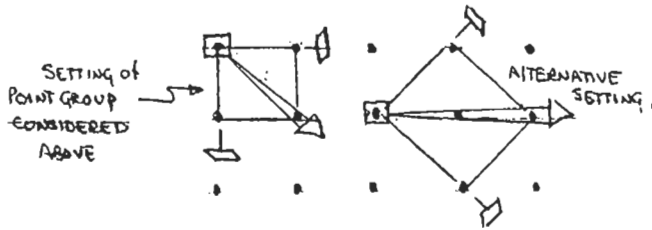

Note that the square base of the cell may be redefined as a centered double net which is also square. (The primitive tetragonal lattice thereby becoming base-centered, the body-centered tetragonal lattice becoming face-centered). It may now be readily appreciated that the four-fold axes may also be oriented normal to the faces of these redundant multiple cells, and the three-fold axes along the

body diagonal. As above, symmetry requires the lattices to become cubic with all faces equivalent. Both tetragonal lattices thus become Face-Centered Cubic for this point group setting.

There are thus 14 unique space lattices.

3.60 Symmetry, Structure and Tensor Properties of Materials

LATTICE TRANSFORMATIONS

SUPPOSE WE HAVE DEFINED A LATTICE IN TERMS OF THE USUAL THREE NON-COPLANAR TRANSLATIONAL PERIODICITIES $\vec{a}, \vec{b}, \vec{c}$ (CONJUGATE TRANSLATIONS) AND NOW CHOOSE INSTEAD TO DEFINE THE LATTICE IN TERMS OF A NEW SET $\vec{a}', \vec{b}', \vec{c}'$. AS WE USE THE THREE TRANSLATIONS, THE CELL EDGES, AS THE BASIS VECTORS OF THE COORDINATE SYSTEM WITH RESPECT TO WHICH FEATURES OF THE LATTICE ARE REFERRED — COORDINATES OF POINTS, DIRECTIONS, PLANES — THE INDICES USED TO DEFINE THESE FEATURES CLEARLY MUST CHANGE AS WELL. THE RECIPROCAL LATTICE TRANSLATIONS WILL ALSO CHANGE. WE HERE CONSIDER THE PROBLEM OF OBTAINING THESE INDICES IN TERMS OF THE ORIGINAL VALUES AND THE MATRIX WHICH RELATES THE NEW LATTICE VECTORS TO THE ORIGINAL CHOICE.

① RELATION BETWEEN LATTICES

AS LATTICE POINTS REPRESENT RATIONAL (INTEGER) COORDINATES, AND THE NEW TRANSLATION VECTORS ALSO EXTEND BETWEEN LATTICE POINTS, THE NEW TRANSLATIONS MAY BE EXPRESSED AS A LINEAR COMBINATION OF THE ORIGINAL VECTORS, AND THE COEFFICIENTS IN THE VECTOR SUM WILL BE ENTIRELY INTEGERS IF TWO PRIMITIVE CELLS ARE INVOLVED IN THE TRANSFORMATION.

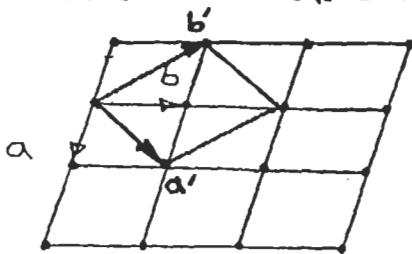

IN THE EXAMPLE TO THE LEFT (IN TWO DIMENSIONS) FOR EXAMPLE:

$$\begin{cases} \vec{a}' = \vec{a} + \vec{b} \\ \vec{b}' = -\vec{a} + \vec{b} \end{cases}$$

AS GENERAL

$$\begin{cases} \vec{a}' = S_{11}\vec{a} + S_{12}\vec{b} + S_{13}\vec{c} \\ \vec{b}' = S_{21}\vec{a} + S_{22}\vec{b} + S_{23}\vec{c} \\ \vec{c}' = S_{31}\vec{a} + S_{32}\vec{b} + S_{33}\vec{c} \end{cases}$$

OR, MORE COMPACTLY,

$$[\vec{a}'_i] = [S_{ij}] [\vec{a}_j]$$

WHERE $a_1 \equiv a, a_2 \equiv b, a_3 \equiv c$, ETC

$[S_{ij}]$ IS CALLED THE MATRIX OF THE TRANSFORMATION

Examples:

C-CENTERED LATTICE IN TERMS OF PRIMITIVE CELL WITH DIAMOND BASE

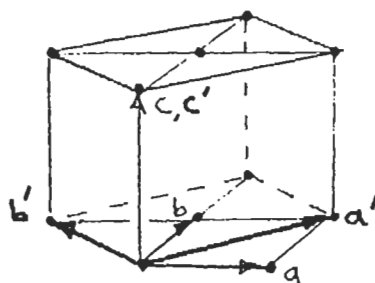

$$\begin{cases} \vec{a}' = \vec{a} + \vec{b} \\ \vec{b}' = -\vec{a} + \vec{b} \\ \vec{c}' = \vec{c} \end{cases}$$

$$[S_{ij}] = \begin{bmatrix} 1 & 1 & 0 \\ -1 & 1 & 0 \\ 0 & 0 & 1 \end{bmatrix}$$

FACE-CENTERED CUBIC IN TERMS OF PRIMITIVE RHOMBOHEDRAL

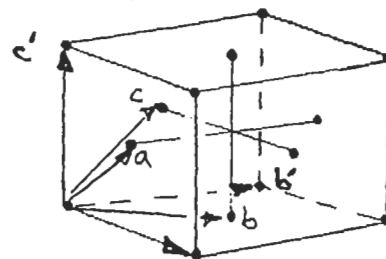

$$\begin{cases} \vec{a}' = \vec{a} + \vec{b} - \vec{c} \\ \vec{b}' = -\vec{a} + \vec{b} + \vec{c} \\ \vec{c}' = \vec{a} - \vec{b} + \vec{c} \end{cases} \quad [S_{ij}] = \begin{bmatrix} 1 & 1 & -1 \\ -1 & 1 & 1 \\ 1 & -1 & 1 \end{bmatrix}$$

FRACTIONAL MATRIX ELEMENTS S_{ij} MAY BE INVOLVED IN TRANSFORMATION MATRICES WHICH EXPRESS A NON-PRIMITIVE CELL IN TERMS OF ANOTHER, OR A PRIMITIVE CELL IN TERMS OF THE TRANSLATIONS WHICH DEFINE A MULTIPLE CELL.

THIS FAR WE HAVE TALKED ABOUT MATRICES WHICH INVOLVE GOING FROM ONE DESCRIPTION TO ANOTHER OF THE SAME LATTICE. THE FORMALISM IS ALSO USEFUL, HOWEVER, IN DESCRIBING SUBSTRUCTURE - SUPERCELL RELATIONS (AS THE TRANSLATION GROUP OF THE SUPERCELL IS A SUBGROUP OF THE TRANSLATION GROUP OF THE IDEAL STRUCTURE)

EXAMPLE: $PbAgAsS_3$ - A SUPERSTRUCTURE WHICH WE STUDIED A FEW YEARS AGO IN WHICH THE THREE METAL SPECIES ORDER AMONG THE CATION POSITIONS IN THE ROCKSALT STRUCTURE TYPE TO GIVE A MONOCLINIC PSEUDO-ORTHORHOMBIC SUPERCELL.

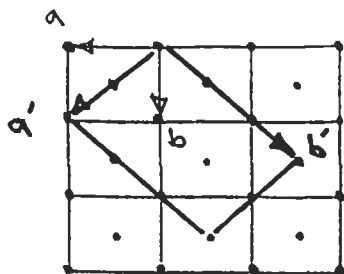

$$\begin{cases} a' = a + b \\ b' = \frac{1}{2}a + \frac{1}{2}b \\ c' = c \end{cases}$$

$$[S_{ij}] = \begin{bmatrix} 1 & 1 & 0 \\ \frac{1}{2} & \frac{1}{2} & 0 \\ 0 & 0 & 1 \end{bmatrix}$$

(NOTE THE APPEARANCE OF NON-INTEGERS AS THE ORIGINAL CELL WAS NON-PRIMITIVE)

THE REVERSE TRANSFORMATION

$$\text{if } [a'_i] = [S_{ij}] [a_j]$$

WE CAN WRITE, IN TERMS OF MATRIX ALGEBRA:

$$[a_j] = [S_{ij}]^{-1} [a'_i] \quad \text{WHERE } [S_{ij}]^{-1} \text{ IS THE INVERSE OF THE MATRIX OF THE TRANSFORMATION, } [S_{ij}].$$

LET US EVALUATE $[S_{ij}]^{-1}$ IN ORDER TO REVIEW A FEW DEFINITIONS AND THE METHOD FOR EVALUATION OF DETERMINANTS

$$\text{if } \begin{cases} a' = S_{11}a + S_{12}b + S_{13}c \\ b' = S_{21}a + S_{22}b + S_{23}c \\ c' = S_{31}a + S_{32}b + S_{33}c \end{cases}$$

THE KRAMER'S RULE STATES THAT EACH OF THE ORIGINAL VARIABLES (a, b, c) MAY BE WRITTEN AS THE RATIO OF TWO 3x3 DETERMINANTS: THE DENOMINATOR IS THE DETERMINANT $|S_{ij}|$, THE NUMERATOR IS THE DETERMINANT OF THE ARRAY S_{ij} BUT IN WHICH THE COLUMN IN WHICH THE DESIRED VARIABLE APPEARS IS REPLACED BY a', b', c'

EXAMPLE:

$$a = \frac{\begin{vmatrix} a' & S_{12} & S_{13} \\ b' & S_{22} & S_{23} \\ c' & S_{32} & S_{33} \end{vmatrix}}{\begin{vmatrix} S_{11} & S_{12} & S_{13} \\ S_{21} & S_{22} & S_{23} \\ S_{31} & S_{32} & S_{33} \end{vmatrix}}$$

THE RULE FOR EXPANDING A DETERMINANT IS THAT $|S_{ij}|$ IS THE PRODUCT OF THE THREE ELEMENTS IN ANY ROW OR COLUMN TIMES THE 2x2 DETERMINANT WHICH REMAINS UPON DELETING THE ROW AND COLUMN IN WHICH THE CORRESPONDING ELEMENT IS SITUATED, TIMES $(-1)^{i+j}$ [EQUIVALENT TO STARTING WITH + IN ANY CORNER OF THE ARRAY AND CHANGING SIGN +, -, +, - ETC UPON SKIPPING ALONG ANY ROW OR COLUMN - i.e., $\begin{vmatrix} + & - & + \\ - & + & - \end{vmatrix}$]

EXPANDING $|S_{ij}|$ AS AN EXAMPLE:

$$|S_{ij}| = (-1)^2 S_{11} \begin{vmatrix} S_{22} & S_{23} \\ S_{32} & S_{33} \end{vmatrix} + (-1)^3 S_{21} \begin{vmatrix} S_{12} & S_{13} \\ S_{32} & S_{33} \end{vmatrix} + (-1)^{3+1} S_{31} \begin{vmatrix} S_{12} & S_{13} \\ S_{22} & S_{23} \end{vmatrix}$$

EXPANDING THE 2x2 DETERMINANTS ACCORDING TO THE SAME RULE GIVES

$$|S_{ij}| = S_{11}(S_{22}S_{33} - S_{32}S_{23}) - S_{21}(S_{12}S_{33} - S_{32}S_{13}) + S_{31}(S_{12}S_{23} - S_{22}S_{13})$$

THE COFACTOR OF AN ELEMENT S_{ij} IS DEFINED AS $(-1)^{i+j}$ TIMES THE 2x2 DETERMINANT WHICH REMAINS UPON DELETING THE ROW AND COLUMN IN WHICH THE ELEMENT APPEARS. THUS, THE FIRST EQUATION FOR THE EXPANSION MAY BE WRITTEN

$$|S_{ij}| = S_{11} \text{Cof } S_{11} + S_{21} \text{Cof } S_{21} + S_{31} \text{Cof } S_{31} \quad (= S_{11} \text{Cof } S_{11} + S_{12} \text{Cof } S_{12} + S_{13} \text{Cof } S_{13} \text{ ETC.})$$

RETURNING TO OUR EXPRESSION FOR a AS A FUNCTION OF THE RATIO OF TWO DETERMINANTS, AND EXPANDING THE NUMERATOR GIVES

$$a = \left\{ a' \text{Cof } S_{11} + b' \text{Cof } S_{21} + c' \text{Cof } S_{31} \right\} \frac{1}{|S_{ij}|}$$

AS THE COEFFICIENT MODIFYING THE TERMS a' , b' & c' ARE, BY DEFINITION, THE DESIRED ELEMENTS OF THE INVERSE MATRIX, WE HAVE SHOWN THAT

$$S_{11}^{-1} = \frac{\text{Cof } S_{11}}{|S_{ij}|} \quad S_{12}^{-1} = \frac{\text{Cof } S_{21}}{|S_{ij}|} \quad S_{13}^{-1} = \frac{\text{Cof } S_{31}}{|S_{ij}|}$$

OR, IN GENERAL,

$$S_{ij}^{-1} = \frac{\text{Cof } S_{ji}}{|S_{ij}|}$$

WHICH IS TO SAY THAT IF YOU WANT THE ELEMENT OF THE INVERSE MATRIX WHICH SITS HERE

$$\begin{bmatrix} S_{ij}^{-1} \end{bmatrix} = \begin{bmatrix} \cdot & \cdot & \cdot \\ \cdot & \cdot & \cdot \\ \cdot & \cdot & \cdot \end{bmatrix}$$

THEN YOU GO AFTER THE COFACTOR OF THE TERM IN THE MATRIX $[S_{ij}]$ WHICH SITS HERE

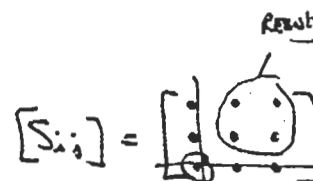

RELATION BETWEEN VOLUME OF TWO CELLS

$$\text{If } [a'_i] = [S_{ij}] [a_j]$$

$$\text{then } \boxed{V' = |S_{ij}| V}$$

WHERE V' AND V ARE THE VOLUMES OF THE NEW AND OLD UNIT CELLS, RESPECTIVELY

WE WILL NOT BOTHER TO PROVE THIS RELATION. THE RESULT MAY BE DEMONSTRATED STRAIGHTFORWARDLY BY WRITING $V' = \vec{a}' \times \vec{b}' \cdot \vec{c}'$ EXPRESSING a' , b' & c' IN TERMS OF a , b & c USING THE MATRIX OF THE TRANSFORMATION, AND SHOWING THAT THE RESULTING COLLECTION OF ELEMENTS S_{ij} IS EQUIVALENT TO $|S| \cdot \vec{a} \times \vec{b} \cdot \vec{c}$

② TRANSFORMATION OF INDICES

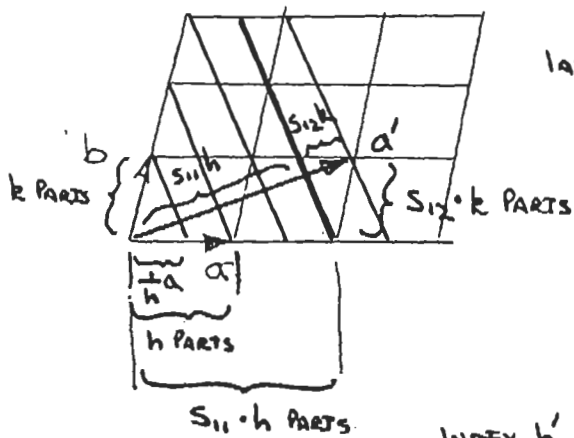

RECALL THAT, IN A STACK OF TRANSLATION-EQUIVALENT LATTICE PLANES WITH MILLER INDICES (hkl) , THE FIRST PLANE FROM THE ORIGIN INTERCEPTS \vec{a} , \vec{b} AND \vec{c} AT $\frac{1}{h}$, $\frac{1}{k}$ & $\frac{1}{l}$ RESPECTIVELY.

STATED IN A DIFFERENT WAY, SINCE ALL PLANES ARE EQUIDISTANT FROM EACH OTHER, A STACK OF PLANES WITH INDICES (hkl) DIVIDES THE TRANSLATION \vec{a} INTO h INTERVALS, \vec{b} INTO k AND \vec{c} INTO l . WE MAY THUS DETERMINE THE NEW

INDEX h' APPROPRIATE TO THE NEW AXIS a' BY ENUMERATING THE NUMBER OF INTERVALS INTO WHICH OUR STACK OF PLANES DIVIDES a'

SUPPOSE \vec{a}' IS DEFINED BY A STEP $S_{11}\vec{a}$ ALONG \vec{a} , A STEP $S_{12}\vec{b}$ ALONG \vec{b} AND $S_{13}\vec{c}$ ALONG \vec{c} .

IF THE PLANES DIVIDE a INTO h PARTS THEY DIVIDE $S_{11}\vec{a}$ TRANSLATIONS INTO $S_{11} \cdot h$ PARTS AND ALSO INTERCEPT a' AS $S_{11}h$ INTERVALS TO THIS POINT (SEE DIAGRAM) SIMILARLY THE PLANES DIVIDE THE LEG $S_{12}\vec{b}$ INTO $S_{12} \cdot k$ PARTS AND ALSO INTERCEPT a' IN $S_{12}k$ INTERVALS. USING A SIMILAR ARGUMENT FOR A STEP OF $S_{13}\vec{c}$ ALONG \vec{c} , ONE FINDS THAT \vec{a}' IS CUT INTO $S_{11}h + S_{12}k + S_{13}l$ PARTS AND THUS

$$\left. \begin{aligned} h' &= S_{11}h + S_{12}k + S_{13}l \\ \text{Similarly } k' &= S_{21}h + S_{22}k + S_{23}l \\ \text{AND } l' &= S_{31}h + S_{32}k + S_{33}l \end{aligned} \right\}$$

$$\text{OR } [h'_i] = [S_{ij}] [h_j]$$

WHERE $h_1 \equiv h$, $h_2 \equiv k$, $h_3 \equiv l$ ETC

THAT IS, MILLER INDICES OF PLANES (hkl) TRANSFORM ACCORDING TO THE SAME RELATIONS AS DO LATTICE TRANSLATIONS!

③ TRANSFORMATION OF RECIPROCAL AXES

THE RECIPROCAL LATTICE TRANSLATION \vec{a}^* IS DEFINED BY

$$\vec{a}^* = \frac{\vec{b} \times \vec{c}}{V}$$

$$\text{SO } \vec{a}^{*'} = \frac{\vec{b}' \times \vec{c}'}{V'} = \frac{\vec{b}' \times \vec{c}'}{|S_{ij}|V}$$

$$= \frac{1}{|S_{ij}|V} [(S_{21}\vec{a} + S_{22}\vec{b} + S_{23}\vec{c}) \times (S_{31}\vec{a} + S_{32}\vec{b} + S_{33}\vec{c})]$$

$$= \frac{1}{|S_{ij}|V} [S_{21}S_{31}\vec{a} \times \vec{a} + S_{21}S_{32}\vec{a} \times \vec{b} + S_{21}S_{33}\vec{a} \times \vec{c} + S_{22}S_{31}\vec{b} \times \vec{a} + S_{22}S_{32}\vec{b} \times \vec{b} + S_{22}S_{33}\vec{b} \times \vec{c} + S_{23}S_{31}\vec{c} \times \vec{a} + S_{23}S_{32}\vec{c} \times \vec{b} + S_{23}S_{33}\vec{c} \times \vec{c}]$$

REARRANGING, AND NOTING $\vec{u}_1 \times \vec{u}_2 = -\vec{u}_2 \times \vec{u}_1$,

$$= \frac{1}{|S_{ij}|} \left\{ (S_{22}S_{33} - S_{23}S_{32}) \frac{\vec{b} \times \vec{c}}{V} + (S_{23}S_{31} - S_{21}S_{33}) \frac{\vec{c} \times \vec{a}}{V} + (S_{21}S_{32} - S_{12}S_{31}) \frac{\vec{a} \times \vec{b}}{V} \right\}$$

$$\text{so } \vec{a}^{*'} = \frac{(S_{22}S_{33} - S_{23}S_{32})}{|S_{ij}|} \vec{a}^* - \frac{(S_{21}S_{23} - S_{23}S_{31})}{|S_{ij}|} \vec{b}^* + \frac{(S_{21}S_{32} - S_{23}S_{22})}{|S_{ij}|} \vec{c}^*$$

This combination of elements is Cof S_{11}

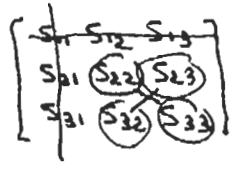

This combination of elements is Cof S_{12}

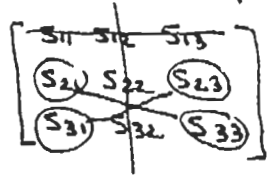

This combination is Cof S_{13}

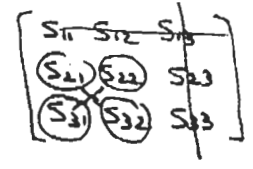

$$\text{Thus } \vec{a}^{*'} = \frac{\text{Cof } S_{11}}{|S_{ij}|} \vec{a}^* + \frac{\text{Cof } S_{12}}{|S_{ij}|} \vec{b}^* + \frac{\text{Cof } S_{13}}{|S_{ij}|} \vec{c}^*$$

OR, IN GENERAL
$$[a_i^{*'}] = \left[\frac{\text{Cof } S_{ij}}{|S_{ij}|} \right] [a_j^*]$$

This looks suspiciously like the INVERSE of the matrix $[S_{ij}]$, BUT IT'S NOT! — THE SUBSCRIPTS ARE IN THE WRONG ORDER [that is, to find the element S_{ij}^{-1} we evaluate the cofactor of S_{ji} . HERE WE PUT THE COFACTOR i,j DIRECTLY IN THE i,j SLOT] THE MATRIX RELATING $[a_i^{*'}]$ TO $[a_j^*]$ IS THUS THE INVERSE MATRIX $[S_{ij}]^{-1}$ WITH ROWS & COLUMNS INTERCHANGED A MATRIX SO TRANSFORMED IS SAID TO BE THE TRANSPOSE AND IS WRITTEN $[\tilde{a}_{ij}]$.

i.e. $[\tilde{a}_{ij}] \equiv [a_{ji}]$

thus
$$[a_i^{*'}] = [\tilde{S}_{ij}]^{-1} [a_j^*]$$

that is, RECIPROCAL LATTICE TRANSFORMATIONS TRANSFORM AS THE TRANSPOSE OF THE INVERSE OF THE MATRIX OF THE TRANSFORMATION

PRACTICAL NOTES:

(a) is the order important? that is, is the transpose of the inverse the same as the inverse of the transpose? SURE. DOESN'T MATTER WHETHER WE TRANSPOSE FIRST AND THEN EVALUATE THE COFACTOR OF THE TRANSPOSED ELEMENT OR EVALUATE THE COFACTOR OF THE TRANSPOSED ELEMENT AND THEN TRANSPOSE THE RESULT

(b) If one can write the new axes as a vector sum of the original axes according to $[a_i'] = [S_{ij}][a_j^*]$ TO INITIATE THE WHOLE BUSINESS, ONE COULD JUST AS EASILY WRITE THE OLD AXES IN TERMS OF THE NEW — THAT IS, $[a_j^*] \equiv [T_{ij}][a_i']$ — BY INSPECTION. CLEARLY THEN, $[T_{ij}]$ IS $[S_{ij}]^{-1}$ DIRECTLY, AND $[\tilde{T}_{ij}]$ GIVES DIRECTLY THE RELATION BETWEEN $a_i^{*'}$ AND a_j^* WITHOUT THE BOTHER OF EVALUATING THE INVERSE OF $[S_{ij}]$.

(clearly, TO INVERSE IS WORSE THAN TRANSPOSE, ONE KNOWS)

④ TRANSFORMATION OF COORDINATES

⑥

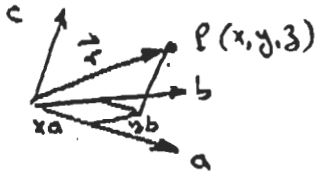

COORDINATES OF A POINT WITHIN THE UNIT CELL x, y, z MAY BE CONSIDERED AS THE COMPONENTS $x\vec{a}, y\vec{b}, z\vec{c}$ OF A VECTOR FROM THE ORIGIN TO THE LOCATION:

$$\vec{r} = x\vec{a} + y\vec{b} + z\vec{c}$$

IN THE NEW COORDINATE SYSTEM ONE MUST WRITE:

$$\vec{r} = x'\vec{a}' + y'\vec{b}' + z'\vec{c}'$$

$$\text{if } \vec{r} = x\vec{a} + y\vec{b} + z\vec{c}$$

$$\text{AND } \begin{cases} \vec{a} = s_{11}^{-1}\vec{a}' + s_{12}^{-1}\vec{b}' + s_{13}^{-1}\vec{c}' \\ \vec{b} = s_{21}^{-1}\vec{a}' + s_{22}^{-1}\vec{b}' + s_{23}^{-1}\vec{c}' \\ \vec{c} = s_{31}^{-1}\vec{a}' + s_{32}^{-1}\vec{b}' + s_{33}^{-1}\vec{c}' \end{cases}$$

where s_{ij}^{-1} is the element ij in the INVERSE of the MATRIX of the TRANSFORMATION

$$\begin{aligned} \text{SUBSTITUTING, } \vec{r} &= x(s_{11}^{-1}\vec{a}' + s_{12}^{-1}\vec{b}' + s_{13}^{-1}\vec{c}') \\ &+ y(s_{21}^{-1}\vec{a}' + s_{22}^{-1}\vec{b}' + s_{23}^{-1}\vec{c}') \\ &+ z(s_{31}^{-1}\vec{a}' + s_{32}^{-1}\vec{b}' + s_{33}^{-1}\vec{c}') \\ &= (s_{11}^{-1}x + s_{21}^{-1}y + s_{31}^{-1}z)\vec{a}' + (s_{12}^{-1}x + s_{22}^{-1}y + s_{32}^{-1}z)\vec{b}' \\ &+ (s_{13}^{-1}x + s_{23}^{-1}y + s_{33}^{-1}z)\vec{c}' \end{aligned}$$

$$\text{But } \vec{r} = x'\vec{a}' + y'\vec{b}' + z'\vec{c}'$$

from which, comparing terms,

$$\begin{cases} x' = s_{11}^{-1}x + s_{21}^{-1}y + s_{31}^{-1}z \\ y' = s_{12}^{-1}x + s_{22}^{-1}y + s_{32}^{-1}z \\ z' = s_{13}^{-1}x + s_{23}^{-1}y + s_{33}^{-1}z \end{cases}$$

$$\text{OR } [x'_i] = [s_{ji}^{-1}] [x_j]$$

$$\boxed{[x'_i] = [\tilde{s}_{ij}^{-1}] x_j}$$

ATOMIC COORDINATES TRANSFORM ACCORDING TO THE SAME RELATION AS DO RECIPROCAL LATTICE TRANSFORMATIONS — i.e., the TRANSPOSE of the INVERSE of the MATRIX of the TRANSFORMATION.

SUMMARY

$$[a'_i] = [s_{ij}] [a_j]$$

$$[h'_i] = [s_{ij}] [h_j]$$

$$[a_i^*] = [\tilde{s}_{ij}]^{-1} [a_j^*]$$

$$[x'_i] = [\tilde{s}_{ij}]^{-1} [x_j]$$

OR if ONE WRITES DIRECTLY

$$[a_i] = [T_{ij}] [a'_j] \quad [T_{ij}] \equiv [s_{ij}]^{-1}$$

$$[h_i] = [T_{ij}] [h'_j]$$

then

$$[a_i^*] = [\tilde{T}_{ij}] [a_j^*]$$

$$[x'_i] = [\tilde{T}_{ij}] [x_j]$$

3.60 Symmetry, Structure and Tensor Properties of Materials

DISTRIBUTION OF LATTICE TYPES AND POINT GROUPS AMONG THE CRYSTAL SYSTEMS

SYSTEM (6)	LATTICES (14)	POINT GROUPS (32)	LAVIE GROUP (11)
TRICLINIC $a \neq b \neq c$ $\alpha \neq \beta \neq \gamma$	PRIMITIVE	1 $\bar{1}$	$\bar{1}$
MONOCLINIC $a \neq b \neq c$ $\alpha = \beta = 90^\circ \neq \gamma$	PRIMITIVE SIDE-CENTERED \equiv BODY CENT.	2 C_2 C_2/m	C_2/m
ORTHORHOMBIC $a \neq b \neq c$ $\alpha = \beta = \gamma = 90^\circ$	PRIMITIVE SIDE-CENTERED BODY-CENTERED FACE-CENTERED	222 C_2 C_2/m C_2/m C_2/m	C_2/m C_2/m C_2/m
TETRAPGONAL $a_1 = a_2 \neq c$ $\alpha = \beta = \gamma = 90^\circ$	PRIMITIVE BODY-CENTERED	4 $\bar{4}$ C_4	C_4
HEXAGONAL $a_1 = a_2 \neq c$ $\alpha = \beta = 90^\circ \neq \gamma = 120^\circ$ [Rhombohedral or TRIGONAL [$a_1 = a_2 = a_3$ [$\alpha_1 = \alpha_2 = \alpha_3$]]]	PRIMITIVE (only)	6 C_6 C_3 C_2 C_6/m C_3/m C_2/m	C_6 C_3 C_2 C_6/m C_3/m
	" (or) Rhombohedral	3 2 C_3 C_2 C_3 C_3/m C_2	C_3 C_2 C_3 C_3/m
ISOMETRIC OR CUBIC $a_1 = a_2 = a_3$ $\alpha = \beta = \gamma = 90^\circ$	PRIMITIVE BODY-CENTERED FACE-CENTERED	23 C_4 C_3 C_2 C_3 C_2 C_4 C_2 C_3 432 C_4 C_3 C_2 C_4 C_2 C_3	C_2/m C_3 C_4 C_2 C_3 C_2 C_4 C_2 C_3 C_4 C_2 C_3 C_2 C_4 C_2 C_3

3.60 Symmetry, Structure and Tensor Properties of Materials

SYMBOLS FOR THE LOCUS OF A GLIDE PLANE :

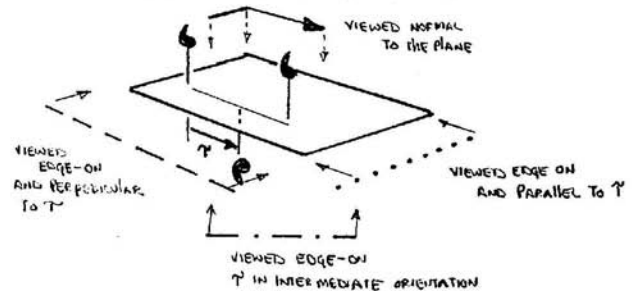

ANALYTICAL SYMBOLS FOR A GLIDE PLANE

AXIAL GLIDES $\left\{ \begin{array}{l} \tau = \frac{1}{2} a \quad \text{a-GLIDE} \\ \tau = \frac{1}{2} b \quad \text{b-GLIDE} \\ \tau = \frac{1}{2} c \quad \text{c-GLIDE} \end{array} \right.$

DIAGONAL GLIDES $\left\{ \begin{array}{l} \tau = \frac{1}{2} (a \pm b) \\ \tau = \frac{1}{2} (b \pm c) \\ \tau = \frac{1}{2} (c \pm a) \end{array} \right. \quad \left. \begin{array}{l} \\ \\ \end{array} \right\} \text{ n-GLIDE}$

DIAMOND GLIDES $\left\{ \begin{array}{l} \tau = \frac{1}{4} (a \pm b) \\ \tau = \frac{1}{4} (b \pm c) \\ \tau = \frac{1}{4} (c \pm a) \\ \tau = \frac{1}{4} (a \pm b \pm c) \end{array} \right. \quad \left. \begin{array}{l} \\ \\ \\ \end{array} \right\} \text{ d-GLIDE (POSSIBLE ONLY FOR NON-PRIMITIVE CELLS)}$

(THESE SYMBOLS REPLACE THE SYMBOL FOR m IN THE POINT-GROUP PORTION OF THE SPACE GROUP SYMBOL IF THE SYMMETRY ELEMENT IS PRESENT — $cg, P2/a$)

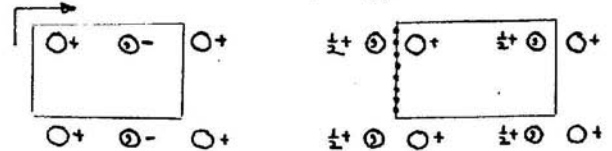

ABOVE ARE TWO EXAMPLES OF HOW GLIDE-PLANES MIGHT APPEAR IN SPACE-GROUP DIAGRAMS.

Figure removed for copyright reasons.

Source: Buerger, Martin J. Elementary Crystallography: An Introduction to the Fundamental Geometrical Features of Crystals. Cambridge, MA: MIT Press, 1978. ISBN: 0262520486.

3.60 Symmetry, Structure and Tensor Properties of Materials

A SUMMARY (CALL ON A SINGLE PAGE !!) OF THE LOGIC USED TO DEFINE THE SPACE GROUPS ALONG WITH THE COMBINATION THEOREMS USED IN EACH STEP.

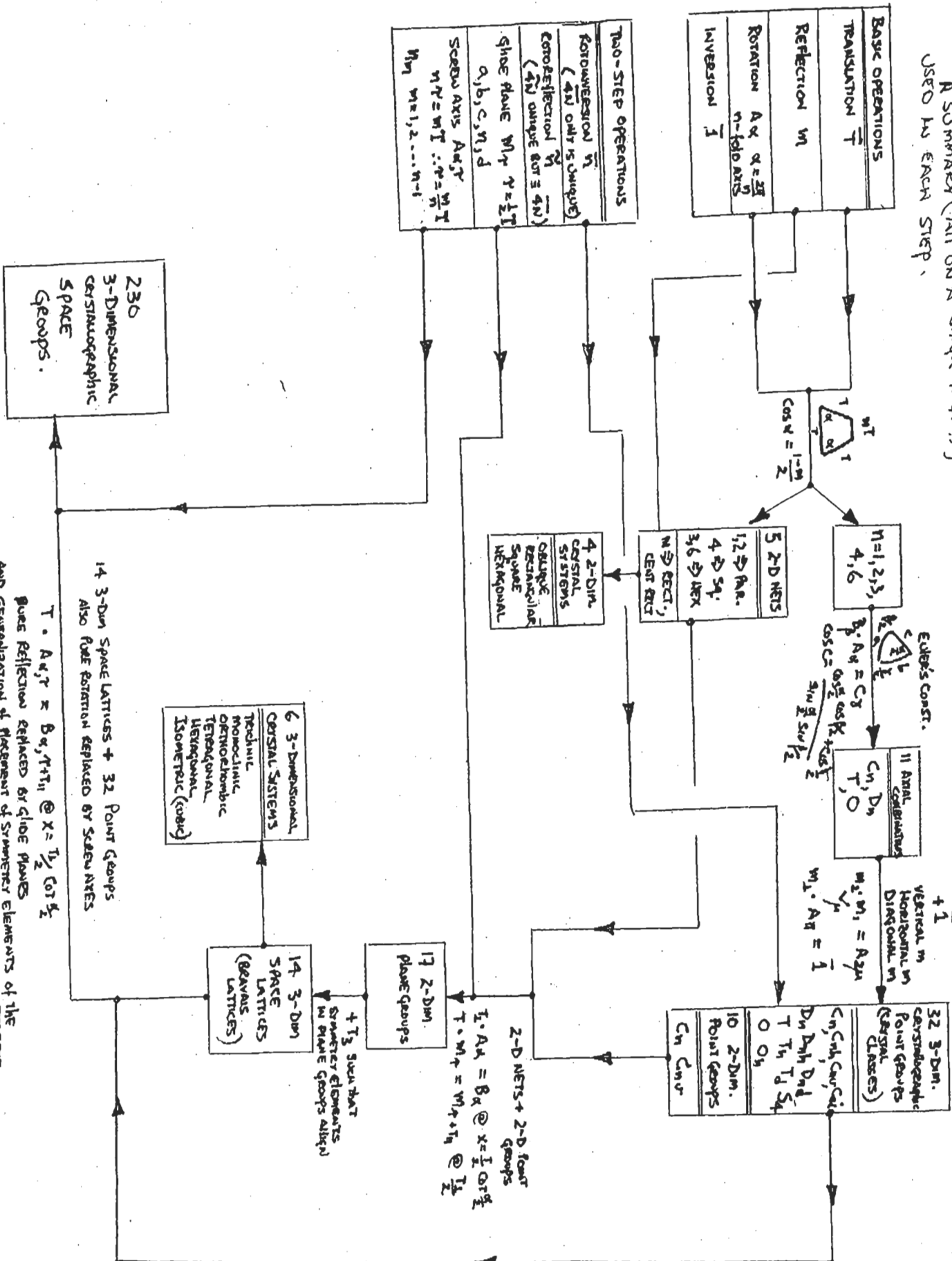

3.60 Symmetry, Structure and Tensor Properties of Materials

IN THIS INTRODUCTORY LECTURE WE WILL USE SOME SIMPLE ELECTROSTATIC PRINCIPLES, WITH WHICH YOU ARE VERY FAMILIAR, PLUS SOME STRAIGHT FORWARD GEOMETRY TO INTRODUCE SOME FUNDAMENTAL FEATURES OF THE CRYSTALLINE STATE — THE APPEARANCE OF SYMMETRY IN LOW-ENERGY STRUCTURES, THE CONCEPT OF PERIODICITY AND A LATTICE AND, FINALLY, SOME SIMPLE GEOMETRY THAT WILL LEAD YOU TO SOME POWERFUL AND NON-INTUITIVE RESULTS FOR THE PREDICTION OF LIKELY STRUCTURES.

THE LIMITATION ON THESE CONSIDERATIONS IS THAT THE PREDICTIVE POWER IS LIMITED TO IONIC STRUCTURES IN WHICH THE COHESIVE FORCE THAT HOLDS THE ATOMS TOGETHER IS PURELY COULOMBIC. (STRUCTURES HELD TOGETHER BY METALLIC OR COVALENT BONDS ARE MUCH MORE COMPLEX.)

THE FEATURES OF COULOMBIC INTERACTION THAT MAKE THE PRESENT CONSIDERATIONS POSSIBLE IS THAT OUTSIDE THE DISTRIBUTION OF CHARGE ON THE ION THE NET CHARGE MAY BE TREATED AS A POINT AT THE CENTER OF THE ION. THE INTERACTIONS ARE THUS CENTRAL FORCES ACTING THROUGH THE ION CENTERS, AND THE FORCE IS INDEPENDENT OF DIRECTION. A LOW ENERGY STRUCTURE THUS BECOMES A PROBLEM IN EFFICIENT PACKING OF THE IONS

RADIUS RATIO & COORDINATION NUMBER

I. RESTRICTIONS IMPOSED BY THE COORDINATION NUMBER OF ATOM A

$CN_A = 1$

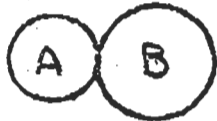

$R_A/R_B = 0 \rightarrow \infty$

$CN_A = 2$



$R_A/R_B = 0 \rightarrow \infty$

$CN_A = 3$

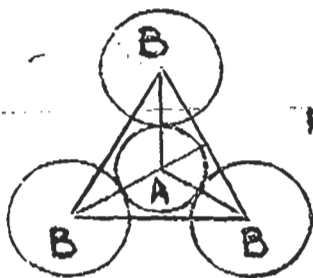

$R_A/R_B = .155 \rightarrow \infty$

$$\frac{R_A + R_B}{R_B} = \frac{2}{\sqrt{3}}$$

$$\frac{R_A}{R_B} = \frac{2}{\sqrt{3}} - 1 = .155$$

$CN_A = 4$

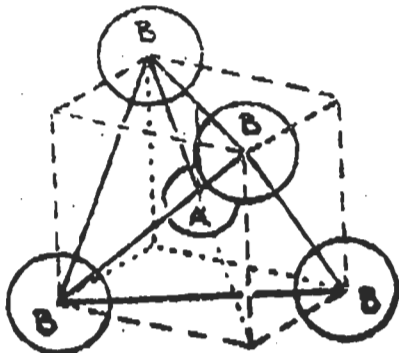

$R_A/R_B = .225 \rightarrow \infty$

$$\frac{R_A + R_B}{R_B} = \frac{\sqrt{3}}{\sqrt{2}}$$

$$\frac{R_A}{R_B} = \frac{\sqrt{3}}{\sqrt{2}} - 1 = .225$$

$$CNA = 6$$

$$R_A/R_B = .414 \rightarrow \infty$$

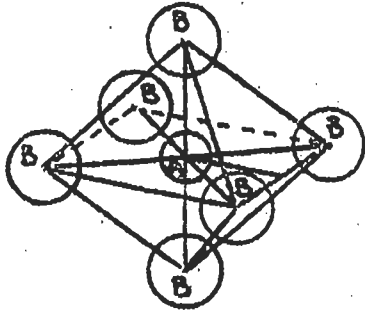

$$\frac{R_A + R_B}{R_B} = \frac{\sqrt{2}}{1}$$

$$R_A/R_B = \sqrt{2} - 1 = .414$$

$$CNA = 8$$

$$R_A/R_B = .732 \rightarrow \infty$$

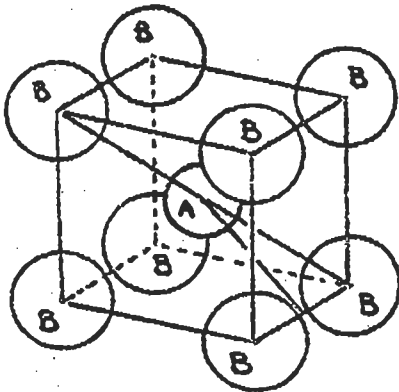

$$\frac{R_A + R_B}{R_B} = \frac{\sqrt{3}}{1}$$

$$R_A/R_B = \sqrt{3} - 1 = .732$$

$$CNA = 12$$

$$R_A/R_B = 1.0 \rightarrow \infty$$

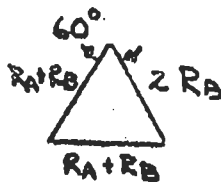
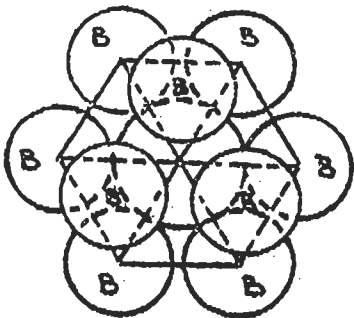

$$\frac{R_A + R_B}{2 R_B} = 1$$

$$R_A/R_B = 2 - 1 = 1.0$$

2. RESTRICTIONS IMPOSED BY THE COORDINATION NUMBER OF ATOM B.

RESULTS ARE THE SAME AS THOSE OBTAINED ABOVE IF WE INTERCHANGE THE LABELING OF THE ATOMS. IF THIS IS DONE, HOWEVER, THE RADIUS RATIO RESTRICTIONS WILL BE IN TERMS OF R_B/R_A . TO EXPRESS ALL RESULTS IN TERMS OF R_A/R_B WE THEREFORE TAKE THE RECIPROCAL OF THE NUMBERS OBTAINED ABOVE.

<u>CN_B</u>	<u>R_B/R_A</u>	<u>R_A/R_B</u>
1	$\infty \rightarrow 0$	$1/\infty \rightarrow 1/0 = 0 \rightarrow \infty$
2	$\infty \rightarrow 0$	$1/\infty \rightarrow 1/0 = 0 \rightarrow \infty$
3	$\infty \rightarrow .155$	$1/\infty \rightarrow 1/.155 = 0 \rightarrow 6.45$
4	$\infty \rightarrow .225$	$1/\infty \rightarrow 1/.225 = 0 \rightarrow 4.44$
6	$\infty \rightarrow .414$	$1/\infty \rightarrow 1/.414 = 0 \rightarrow 2.41$
8	$\infty \rightarrow .732$	$1/\infty \rightarrow 1/.732 = 0 \rightarrow 1.37$
12	$\infty \rightarrow 1.0$	$1/\infty \rightarrow 1/1.0 = 0 \rightarrow 1.0$

RELATION BETWEEN COMPOSITION AND COORDINATION

NUMBER

WE WILL CONSIDER VERY SIMPLE BINARY COMPOUNDS IN WHICH

- (1) THERE IS ONLY ONE TYPE OF A ION AND ONE TYPE OF B ION AND
- (2) A IS COORDINATED ONLY BY B AND VICE VERSA

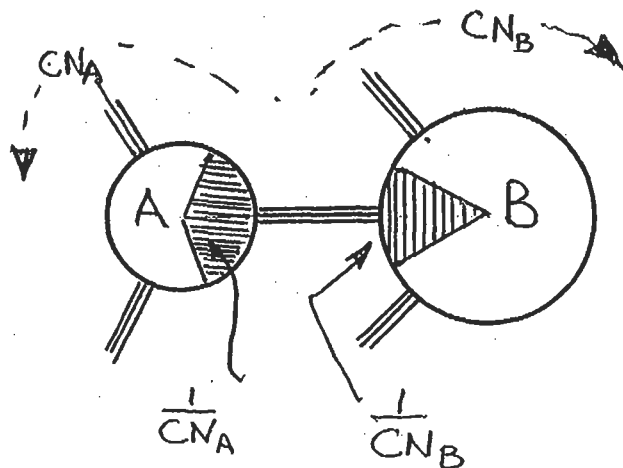

LET A BE SURROUNDED
BY A NUMBER OF
B NEIGHBORS THAT IS
EQUAL TO C_{NA}

LET B BE SURROUNDED BY A NUMBER OF A NEIGHBORS EQUAL
TO C_{NB}

IF WE CONSIDER THE BASIC UNIT OF THE STRUCTURE TO BE
A "BOND" THEN THE COMPOSITION ASSOCIATED WITH THIS
UNIT WILL BE

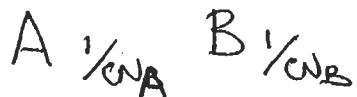

FRACTIONAL SUBSCRIPTS ON A CHEMICAL FORMULA ARE
UGLY — SO LET'S MULTIPLY BY THE INTEGER $C_{NA} \cdot C_{NB}$
TO GET

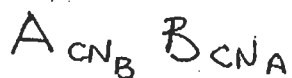

THEREFORE, SUBJECT TO THE ABOVE ASSUMPTIONS,

IN A COMPOUND OF COMPOSITION $A_m B_n$

THE COORDINATION NUMBERS ARE IN RATIO
 $C_{NA} : C_{NB} = m : n$

3. RESTRICTIONS ON RADIUS RATIO RANGES FOR COMPOUNDS.

FOR ANY COMPOUND A_nB_m THE RATIO OF COORDINATION NUMBERS $CNA/CNB = m/n$. MAKING USE OF THE ABOVE RESULTS:

AB COMPOUNDS

$CNA/CNB = 1:1$	$RA/RB = 0 \rightarrow \infty$	
2:2	$RA/RB = 0 \rightarrow \infty$	
3:3	.155 \rightarrow 6.45	
4:4	.225 \rightarrow 4.44	eg: ZnS
6:6	.414 \rightarrow 2.41	eg: NaCl
8:8	.732 \rightarrow 1.37	eg: CsCl
12:12	1 \rightarrow 1	

AB₂ COMPOUNDS

$CNA/CNB = 2:1$	$RA/RB = 0 \rightarrow \infty$	
4:2	.225 \rightarrow ∞	eg: SiO ₂
6:3	.414 \rightarrow 6.45	eg: TiO ₂
8:4	.732 \rightarrow 4.44	eg: CaF ₂
12:6	1 \rightarrow 2.41	

A₂B COMPOUNDS

$CNA:CNB = 1:2$	0 \rightarrow ∞	
2:4	0 \rightarrow 4.44	eg: Cu ₂ O
3:6	.155 \rightarrow 2.41	
4:8	.225 \rightarrow 1.37	eg: Li ₂ O
6:12	.414 \rightarrow 1.0	

A₂B₃ COMPOUNDS

$CNA:CNB = 3:2$.155 \rightarrow ∞	
6:4	.414 \rightarrow 4.44	eg: Al ₂ O ₃
12:8	1 \rightarrow 1.37	

IS THE NOTION OF A "RADIUS" OF AN ION MEANINGFUL?
 NOT REALLY! ATOMS AND IONS ARE FUZZY BALLS OF
 PROBABILITY DENSITY OF THEIR ELECTRONS. THERE ARE SHELLS
 AND LOBES PRESENT THAT ARE SPECIFIED BY THE WAVE FUNCTIONS.

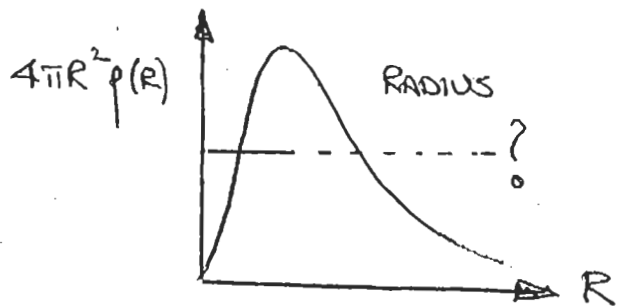

SOMETHING THAT IS ACCESSIBLE
 TO MEASUREMENT BY EXPERIMENT
 ARE INTERATOMIC DISTANCES.
 USING DIFFRACTION TECHNIQUES

ATOMIC POSITIONS IN A CRYSTAL MAY BE MEASURED QUITE
 ACCURATELY — TO ABOUT ONE PART IN 10,000. IF
 THE LOCATIONS OF THE ATOMS ARE FIXED BY SYMMETRY
 THE INTERATOMIC DISTANCES (EG., ONE-HALF OF A CELL EDGE)
 THE INTERATOMIC DISTANCES HAVE THE SAME PRECISION AS THE
 MEASUREMENT OF THE DIMENSIONS OF THE LATTICE. THESE
 MAY BE MEASURED EVEN MORE ACCURATELY; ONE PART
 IN 200,000 OR 0.2×10^{-6} (THERMAL EXPANSION?)

THE INTERIONIC DISTANCE, THEN, MEASURED EXPERIMENTALLY,
 MAY BE TAKEN AS EQUAL TO THE SUM OF THE RADII OF
 THE TWO IONS INVOLVED IN THE INTERACTION.

LET'S SEE HOW WE MIGHT EXTRACT A SYSTEM OF
 RADII, USING THE ALKALI HALIDES AS AN EXAMPLE

NaCl	$R_{Na^+} + R_{Cl^-} = a/2$	TWO RADII, ONE DATUM
KCl	$R_{K^+} + R_{Cl^-} = a/2$	NOW THREE RADII, TWO DATA
NaBr	$R_{Na^+} + R_{Br^-} = a/2$	FOUR RADII, THREE DATA
⋮		
⋮		
n COMPOUNDS		n+1 RADII n OBSERVATIONS

WE CAN'T DO IT!

EXTRACTION OF IONIC RADII FROM SETS OF DATA FOR INTERIONIC DISTANCES

WE CANNOT PERFORM THIS EXERCISE WITHOUT KNOWING THE RADIUS OF AT LEAST ONE SPECIES — WE WILL ALWAYS HAVE ONE MORE UNKNOWN RADIUS THAN EXPERIMENTAL OBSERVATIONS (NOTE THAT HAVING A Cl-Cl DISTANCE AND SETTING R_{Cl} EQUAL TO HALF THE SEPARATION, OR A Na-Na DISTANCE IN ELEMENTAL Na WON'T WORK! THIS INTERACTION WILL BE A COVALENT OR METALLIC BOND WHICH INVOLVES ATOMIC SEPARATIONS THAT ARE QUITE DIFFERENT THAN THOSE IN AN IONIC BOND!)

EARLY ATTEMPTS TO ESTABLISH AN INITIAL RADIUS

(1) ANION-ANION DISTANCES IN LITHIUM HALIDES (LANDÉ, 1920)

WE ILLUSTRATE THIS APPROACH WITH MORE RECENT DATA FOR SOME COMPOUNDS WITH THE ROCK SALT STRUCTURE

MgO	2.10 Å	MnO	2.24 Å
MgS	2.60	MnS	2.59
MgSe	2.73	MnSe	2.73

FROM THESE DATA WE WOULD SAY THAT THE RADIUS FOR S^{2-} IS 0.50 Å GREATER THAN THAT FOR O^{2-} (WHATEVER THAT MIGHT BE!) AND Se^{2-} IS 0.13 Å GREATER THAN S^{2-} , ALSO Mn^{2+} IS 0.14 Å LARGER THAN Mg^{2+}

THE SAME BUT WHY ARE THE ANION-CATION DISTANCES FOR $MgSe$ AND $MnSe$???!
THE ANIONS MUST BE IN CONTACT!

ATTEMPTS TO ESTABLISH AN INITIAL RADIUS TO PERMIT SEPARATION OF INTERIONIC DISTANCES INTO A SET OF SELF-CONSISTENT IONIC RADII

(b) DIMENSIONS OF THE $\text{Si}_2\text{O}_4^{-4}$ TETRAHEDRON IN SILICATES. EARLY USE OF X-RAYS TO DETERMINE THE ATOMIC ARRANGEMENTS IN SILICATES REVEALED A TIGHTLY-BONDED (CHARGES OF +4 AND -2 AND A SMALL INTERIONIC DISTANCE!) TETRAHEDRON WHOSE SIZE AND SHAPE VARIED VERY LITTLE FROM STRUCTURE TO STRUCTURE

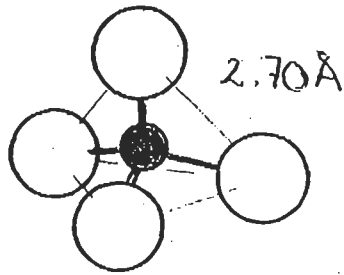

BRAGG (1927) SUGGESTED THAT THIS IS BECAUSE THE STRONG BOND AND SMALL Si^{4+} HAVE PULLED THE OXYGEN IONS INTO CONTACT

THEREFORE, THE RADIUS OF O^{2-} IS 1.35 Å (ACTUALLY, THE $\text{Si}-\text{O}$ BOND IS ONLY ABOUT 50% IONIC. HOWEVER, THIS VALUE IS NOT TOO BAD! - SEE RADIUS TABLES)

(c) POLARIZABILITY AND INDEX OF REFRACTION

DISCOVERY OF SOME PROPERTY THAT WAS A FUNCTION OF IONIC RADIUS WOULD, IN COMBINATION WITH A SET OF INTERIONIC DISTANCES, WOULD ALLOW ONE TO EXTRACT A SET OF IONIC RADII

TWO CHARGES $+q$ AND $-q$, EQUAL IN MAGNITUDE BUT OPPOSITE IN SIGN SEPARATED BY A DISTANCE d DEFINE A DIPOLE MOMENT $\vec{P} \equiv |q|d$

THERE ARE MANY PROBLEMS IN ELECTROMAGNETISM IN WHICH q , \vec{E} , d APPEAR AS A COMBINED QUANTITY AND, MOREOVER, HAVE A VECTOR QUALITY IF WE DEFINE \vec{d} AS POINTING FROM THE \ominus CHARGE TO THE \oplus CHARGE

FOR EXAMPLE, A DIPOLE MOMENT IN AN ELECTRIC FIELD \vec{E} EXPERIENCES A TORQUE $\tau = |\vec{F}| \sin \theta d = q \vec{E} \sin \theta d = \vec{p} \times \vec{E}$

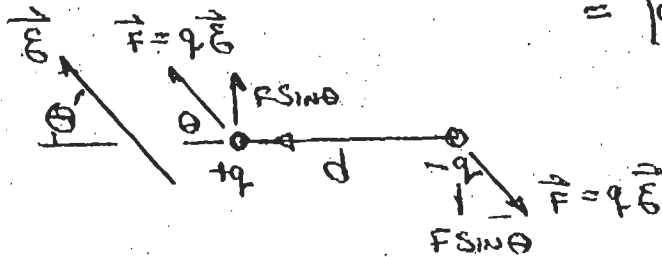

IN ATOMIC SYSTEMS DIPOLE MOMENTS CAN BE EITHER PERMANENT

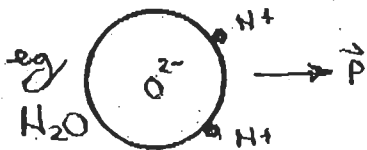

OR INDUCED AS AN ELECTRIC

FIELD ACTING ON AN ATOM WILL PULL THE ELECTRONS AND THE NUCLEUS IN OPPOSITE DIRECTIONS

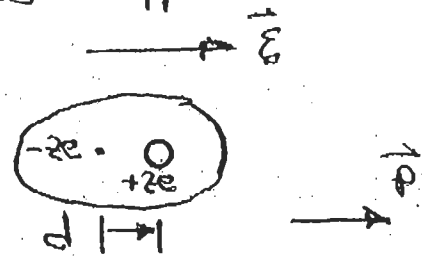
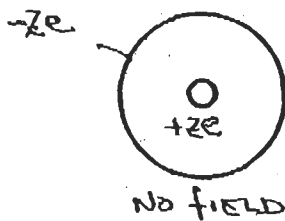

LET'S SET UP A VERY SIMPLE MODEL FOR THE DIPOLE MOMENT INDUCED BY THE ACTION OF AN ELECTRIC FIELD, \vec{E} ON AN ATOM, AND SEE WHAT IT PROVIDES.

THE ACTION OF THE FIELD WILL CREATE A DIPOLE MOMENT

$$\vec{p} = ze d \vec{E}$$

THAT IS PROPORTIONAL TO THE APPLIED ELECTRIC FIELD \vec{E}

$$\vec{p} \propto \vec{E} = \alpha \vec{E}$$

↑ ELECTRONIC POLARIZABILITY

(AN ADVANCE NOTICE OF THINGS TO COME IN THE NEAR FUTURE: \vec{P} IS A VECTOR, \vec{E} IS A VECTOR BUT THERE IS NO REASON WHY \vec{P} MUST BE EXACTLY PARALLEL TO \vec{E} ! THE POLARIZABILITY, THEREFORE, NEED NOT BE A SCALAR NUMBER, BUT INSTEAD, SOMETHING CALLED A TENSOR!)

LET US FURTHER ASSUME THAT THE DENSITY OF ELECTRONS IS UNIFORM (A VERY UNREALISTIC ASSUMPTION!) AND EXTENDS OUT TO A RADIUS R THAT INCLUDES A TOTAL OF Ze CHARGE. WE WILL FURTHER ASSUME THAT THE DISTRIBUTION OF ELECTRONS DISPLACES A DISTANCE \vec{d} RELATIVE TO THE NUCLEUS BUT DOES NOT DEFORM — IT REMAINS A SPHERE OF RADIUS R . (THE REASONS FOR THESE DRASTIC ASSUMPTIONS WILL APPEAR IN THE DEVELOPMENT THAT FOLLOWS!)

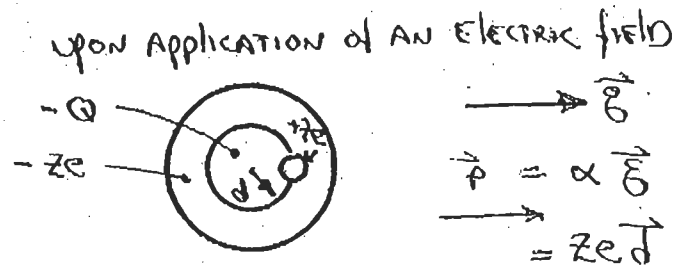
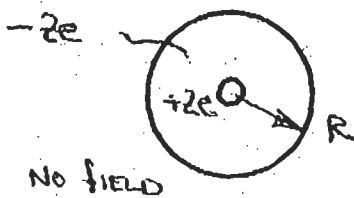

THE ELECTRIC FIELD \vec{E} WILL PULL THE NUCLEUS TO THE RIGHT WITH A FORCE ZeE AND PULL THE SPHERE OF ELECTRONS TO THE LEFT WITH A FORCE $-ZeE$. THE CENTER OF THE ELECTRON DISTRIBUTION WILL, THEREFORE, BE DISPLACED BY A DISTANCE d UNTIL THE ATTRACTION BETWEEN THE SPHERE OF ELECTRONS AND THE NUCLEUS JUST BALANCES THE FORCE EXERTED BY THE ELECTRIC FIELD, \vec{E} .

WE NOW EMPLOY TWO RESULTS OF ELECTROMAGNETISM THAT GREATLY SIMPLIFY THIS PROBLEM.

(a) A CHARGE MOVING WITHIN A UNIFORM SHELL OF CHARGE EXPERIENCES ZERO FORCE ANYWHERE WITHIN THAT SHELL

THE RESTORING FORCE THAT BALANCES THE EFFECT OF THE APPLIED FIELD \vec{E} IS THUS THE ATTRACTION BETWEEN THE NUCLEUS, CHARGE Ze AND THE CHARGE Q THAT IS CONTAINED WITHIN

A sphere of radius d ABOUT THE CENTER OF THE SPHERE OF ELECTRONS.

Q IS THUS PROVIDED BY THE RATIO OF THE VOLUME OF THE SPHERE OF RADIUS d , $\frac{4}{3}\pi d^3$, TO THAT OF THE TOTAL VOLUME OF THE DISTRIBUTION OF ELECTRONS $\frac{4}{3}\pi R^3$

$$Q = \frac{\frac{4}{3}\pi d^3}{\frac{4}{3}\pi R^3} \cdot ze = \frac{d^3}{R^3} ze$$

WE NOW EMPLOY TWO FEATURES OF ELECTROMAGNETIC THEORY TO COMPUTE THE DIPOLE MOMENT AND IONIC POLARIZABILITY OF THE ATOM

(a) A CHARGED PLACED INSIDE OF A UNIFORMLY-CHARGED SPHERICAL SHELL EXPERIENCES NO FORCE AT ANY POSITION WITHIN THE SHELL

(b) ELECTROSTATIC FORCE EXERTED BY A DISTRIBUTION OF CHARGE IS THE SAME AS THAT EXERTED BY A POINT CHARGE AT THE CENTER OF THE DISTRIBUTION FOR LOCATIONS OUTSIDE OF THE DISTRIBUTION.

THE FORCE THAT ACTS TO BALANCE THE SEPARATION OF THE NUCLEUS AND SPHERE OF ELECTRONS IS THUS THE FORCE BETWEEN A CHARGE $+ze$ AND CHARGE $-Q$ SEPARATED BY d , EQUATING THIS TO THE FORCE EXERTED BY THE ELECTRIC FIELD \mathcal{E}

$$ze \mathcal{E} = \frac{1}{4\pi\epsilon_0} \frac{(ze)Q}{d^2} = \frac{1}{4\pi\epsilon_0} \frac{(ze)(ze d^3/R^3)}{d^2}$$

$$\mathcal{E} = \frac{(ze)d}{4\pi\epsilon_0 R^3} \quad \text{SO THAT } d = \frac{4\pi\epsilon_0 R^3}{ze} \mathcal{E}$$

COMPUTING THE DIPOLE MOMENT

$$p = ze d = ze \cdot \frac{4\pi\epsilon_0 R^3}{ze} \mathcal{E} \equiv \alpha \mathcal{E}$$

WE NOTE THAT THE DIPOLE MOMENT INDEED TURNS OUT TO BE PROPORTIONAL TO \mathcal{E} AND THE ^{ELECTRONIC} POLARIZABILITY α IS

$$\boxed{\alpha = 4\pi\epsilon_0 R^3} \quad \alpha \text{ IS PROPORTIONAL TO THE VOLUME OF THE ATOM!}$$

ELECTRONIC POLARIZABILITY α IS RELATED, IN TURN, TO THE INDEX OF REFRACTION, n , OF A MATERIAL BY THE LORENZ-LORENTZ EQUATION.

$$\frac{n^2 - 1}{n^2 + 2} = \frac{4\pi}{3} \sum N_i \alpha_i$$
 WHERE N_i IS THE NUMBER PER UNIT VOLUME OF SPECIES i OR, IN ANOTHER FORM

$$\frac{M}{\rho} \frac{n^2 - 1}{n^2 + 2} = \frac{4\pi}{3} L \alpha$$

WHERE

- M = MOLEC. WT
- ρ = DENSITY
- L = AVOGADRO'S NUMBER
- α = POLARIZABILITY PER "MOLEWT"

THE DIELECTRIC CONSTANT, ϵ , OF A MATERIAL IS RELATED TO INDEX OF REFRACTION n BY

$$\epsilon = n^2$$

THE ABOVE RELATIONS MAY, THEREFORE, BE WRITTEN IN TERMS OF ϵ (UPON WHICH THEY BECOME KNOWN AS THE CLAUSIUS-MOSSOTTI EQUATIONS)

A SETS OF ELECTRONIC POLARIZABILITIES FOR IONS HAS BEEN ESTABLISHED FOR A NUMBER OF SPECIES BY TESSMAN, KAHN AND SHOCKLEY (PHYS. REV. 92 890 (1953))

TABLE OF IONIC RADII (A)

G = Goldschmidt
SKR. NORSKE VIDEHUSK.
AAR. 1, NO. 2 (1926)

P = Pauling
J. AM. CHEM. SOC.
49, 765 (1927)

Z = Zachariasen
Z. KRIST. 80, 137 (1931)

A = Ahrens
Geochim. Cosmochim. Acta 2, 155 (1952)

ION	G	P	A	Z
Ac +3			1.18	1.11
Ag +1	1.13	1.26	1.26	
+2			.89	
Al +3	.57	.50	.51	.45
Am +3			1.07	.99
+4			.92	.89
As +3			.58	
+5		.47	.46	
At +7			.62	
-1				2.27
Au +1		1.37	1.37	
+3			.85	
B +3		.20	.23	.16
Ba +2	1.43	1.35	1.34	1.29
Br +2	.34	.31	.35	.30
Bi +3			.93	
+5		.74	.74	
Br -1	1.96	1.95		1.96
+7			.39	
C +4	.20	.15	.16	.19
Ca +2	1.06	.99	.99	.94
Cd +2	1.03	.97	.97	
Ce +3	1.18		1.07	
+4	1.02	1.01	.94	.92
Cl +7		.26	.27	
-1	1.81	1.81		1.81
Co +2	.82	.92	.73	
+3			.63	
Cr +3	.65		.63	
+6	.34	.52	.52	

FOR A RECENT AND MORE EXTENSIVE COMPILATION SEE:
 R. D. SHANNON & C. T. PREWITT, ACTA CRYSTALLOGRAPHICA B 25, 925-946 (1969).

ION	G	P	A	Z
Cs +1	1.65	1.69	1.67	1.67
Cu +1		.96	.96	
+2			.72	
Dy +3			.92	
Er +3	1.04		.89	
Eu +3			.98	
F +7			.08	
-1	1.33	1.36		1.33
Fe +2	.83	.75	.74	
+3	.67		.64	
Fz +1		1.75	1.80	1.75
Ga +3	.62	.62	.62	
Gd +3	1.11		.97	
Ge +2			.73	
+4	.53	.44	.53	
Hf +4			.78	
Hg +2	1.12	1.10	1.10	
Ho +3			.91	
I +1			.62	
+7		.50	.50	
-1	2.20	2.16		2.19
In +3	.92	.81	.81	
Ir +4	.66	.64	.68	
K +1	1.33	1.33	1.33	1.33
La +3	1.22	1.15	1.14	1.04
Li +1	.78	.60	.68	.68
Lu +3	.99		.85	
Mg +2	.78	.65	.67	.65

ION	G	P	A	Z
Mn +2	.91	.80	.80	
+3	.52	.50	.66	
+4		.46	.60	
+7			.46	
Mo +4	.68	.66	.69	
+6		.62	.62	
N +3			.16	
+5	.1-.2	.11	.13	.1-.2
Nu ₂ +1	1.43			
Na +1	.98	.95	.94	.98
Nb +4			.74	
+5			.69	.67
Nd +3			1.04	
Ni +2	.78	.69	.69	
Np +3			1.10	1.01
+4			.95	.92
+7			.71	
O +6			.10	
-2	1.32	1.40		1.46
Os +4	.67	.65	.69	
P +3			.44	
+5	.3-.4	.34	.35	.34
Pd +3			1.13	1.05
+4			.98	.96
+5			.89	.90
Pb +2	1.32	1.21	1.20	
+4	.84	.84	.84	
Pd +2			.80	
+4			.65	
Pm +3			1.06	
Po +6			.67	
Pr +3	.16		1.06	
Pr +4	1.00	.92	.92	
Pt +2			.80	
+4			.65	
Pu +3			1.03	1.00
+4			.93	.90
Ra +2			1.43	1.37
Rb +1	1.49	1.48	1.47	1.48
Rc +4			.56	
Rh +3	.69		.68	
Ru +4	.65	.63	.67	

ION	G	P	A	Z
S +4			.37	
+6	.34	.29	.30	
-2	1.74	1.84		1.90
Sb +3			.76	
+5		.62	.62	
Sc +3	.83	.81	.81	.68
Se +4			.50	
+6	.3-.4	.42	.42	
-2	1.91	1.98		2.02
Si +4	.39	.41	.42	.38
Sm +3			1.00	
Sn +2			.93	
+4	.74	.71	.71	
Sr +2	1.27	1.13	1.12	1.10
Ta +5			.68	
Tb +3			.93	
+4			.81	
Tc +4			.57	
Te +4	.89	.81	.70	
+6		.56	.56	
-2	2.11	2.21		2.22
Th +4	1.10	1.02	1.02	.99
Ti +3			.76	
+4	.64	.68	.68	.60
Tl +1	1.49	1.44	1.47	
+3	1.05	.95	.95	
Tm +3	1.07		.87	
U +4	1.05	.97	.97	.93
+6			.80	.83
V +2			.95	
+3			.74	
+4	.61	.59	.63	
+5	.4	.59	.59	
W +4	.63	.66	.70	
+6			.62	
Y +3	1.06	.93	.92	.88
Yb +3	1.00		.86	
Zn +2	.83	.74	.74	
Zr +4	.87	.80	.79	.77

Pauling's Rules for Ionic Structures.

(A) A coordination polyhedron of anions is formed about each cation. The cation-anion distance is determined by the sum of their radii. The coordination number is determined by the radius ratio.

(B) Define the "strength" of a cation-anion bond as the ratio of the cation charge to the cation coordination number. In a stable structure the total strength of the bonds that reach an anion in a coordination polyhedron from all neighboring cations is equal to the charge of the anion.

(C) The linkage of coordination polyhedra in a structure is such that edges, and especially faces, tend not to be shared. If edges are shared they tend to be shortened.

(D) Since sharing of polyhedral edges decreases the stability of a structure, cations with high charge and low coordination number especially do not share edges.

(E) The number of different kinds of atoms in a structure tends to be small.

Pauling's Rules for Ionic Structures.

(A) A coordination polyhedron of anions is formed about each cation. The cation-anion distance is determined by the sum of their radii. The coordination number is determined by the radius ratio.

This rule has three statements.

- (a) A coordination polyhedron of anions is formed about each cation (based on the principle that the most stable ionic structure will be one in which the maximum number of anions surround the cation, as the interaction between them is attractive, and vice versa). If a coordination polyhedron of cations is thus formed about the anion as well, why does Pauling mention only the cation coordination polyhedron? The reason is that this is the critical coordination polyhedron that determines the coordination numbers in most ionic structures because the anions are larger than cations.)
- (b) The cation-anion distance is determined by the sum of their radii (well, this is in fact the way we defined the concept of ionic "radii". Two implications of the rule are worth noting. That the distance is determined by the sum of "radii" affirms that establishment of a self-consistent radii is indeed possible. The second aspect of the statement that is worth noting that we will refer to the arrangement of the large anions in many ionic structures as "close packed". This will indeed be the geometry of their placement but the anions are not in contact. The cation-anion distance being equal to the sum of their radii is what determines the anion-anion distance.)
- (c) Coordination number is determined by radius ratio (if the coordination number becomes sufficiently large that the anions touch we have paid the price of larger repulsion without gaining the ^{full} decrease in energy that results from the cohesive cation-anion interaction.)

(B) Define the "strength" of a cation-anion bond as the ratio of the cation charge to the cation coordination number. In a stable structure the total strength of the bonds that reach an anion in a coordination polyhedron from all neighboring cations is equal to the charge of the anion.

This rule — the only one that is quantitative — is a neat way of formulating the expectation that a stable structure will be electrically neutral on an atomic scale as well as macroscopically. Putting all cations in one corner of a cell and placing all anions in the opposite corner would provide a configuration that was electrically neutral, but hardly an arrangement that is one of low energy.

Let's illustrate the application of this rule for rock salt, NaCl, that is described below. The coordination numbers are

in

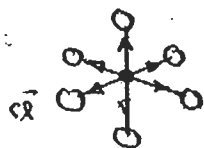

each Na^+ , being surrounded by six Cl^- "donates" a bond of strength

$$S = \frac{+1}{6}$$

each Cl^- is surrounded by six Na^+

the sum of the bond strengths is thus

$$\sum S = 6 \cdot \frac{1}{6} = 1, \text{ the charge on } \text{Cl}^-$$

This result is almost trivial — and will follow for any AB structure because A and B must, from the composition, have the same charge and the same coordination numbers

The structure of spinel, MgAl_2O_4 , provides a less trivial example as there are two cations present with different charge and coordination number.

The coordination number of Mg^{2+} is 4

$$S_{\text{Mg}} = \frac{+2}{4} = \frac{1}{2}$$

The coordination number of Al^{3+} is 6

$$S_{\text{Al}} = \frac{+3}{6} = \frac{1}{2}$$

(SPINEL, CONTINUED)

Each O^{2-} ion in the spinel structure is surrounded by 3 Al^{3+} with bonds that extend in directions that are parallel to the edges of a cube, plus one Mg^{2+} bond in an orientation that corresponds to the body diagonal of a cube.

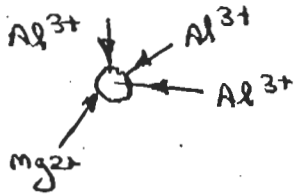

thus

$$\begin{aligned}\sum S &= S_{Mg} + 3 S_{Al} \\ &= \frac{1}{2} + 3 \frac{1}{2} = 2 \text{ THE} \\ &\text{CHARGE OF } O^{2-}\end{aligned}$$

THE RULE ALSO PERMITS THE PREDICTION OF STRUCTURAL FEATURES THAT ARE FAR FROM OBVIOUS!

THE INVARIABLE (WELL ALMOST—THERE EXIST A SMALL HANDFUL OF HIGH PRESSURE OXIDES IN WHICH Si^{4+} ENTERS AN OCTAHEDRAL SITE!) STRUCTURAL UNIT IN SILICATES IS A TIGHTLY BOUND SiO_4^{-4} TETRAHEDRON. THESE TETRAHEDRA OFTEN LINK BY SHARING OF CORNERS (SEE NEXT TWO RULES)

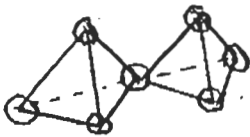

THE BOND STRENGTH DONATED BY Si^{4+} IS

$$S = \frac{+4}{4} = 1$$

FOR THE O^{2-} AT THE SHARED CORNER

$$\sum S = 2 \times \frac{1}{2} = 2$$

THUS SILICATE STRUCTURES CAN FORM A MIND-BOGGLING ARRAY OF STRUCTURES CONTAINING RINGS, CHAINS, SHEETS OR NETWORKS OF TETRAHEDRA BUT ONLY TWO TETRAHEDRA CAN SHARE A CORNER

PHOSPHATE STRUCTURES $P^{5+}O_4^{-3}$ (THE P-O BOND, HOWEVER, HAS CONSIDERABLE COVALENT CHARACTER) WOULD HAVE

$$S = \frac{+5}{4} = 1\frac{1}{4} \text{ THEREFORE } PO_4 \text{ TETRAHEDRA}$$

CANNOT SHARE CORNERS, MUST BE ISOLATED IN PHOSPHATES

Al^{3+} SOMETIMES HAS TETRAHEDRAL COORDINATION BY OXYGEN
BUT $S_{Al} = \frac{+3}{4}$ THUS 4 THE TETRAHEDRA SHARE
CORNERS, THAT OXYGEN ION MUST ALSO BE BONDED TO SOME
ADDITIONAL CATION

LET'S, IN CONCLUSION, CONSIDER THE PHASE $AlPO_4$. THIS
COMPOSITION CAN FORM A NETWORK OF CORNER SHARING TETRAHEDRA
4 THE Al^{3+} AND P^{5+} POLYHEDRA ALTERNATE!

$Al^{3+} \rightarrow \bigcirc \leftarrow P^{5+}$ $\sum S = S_{Al} + S_P$
 $= \frac{3}{4} + \frac{5}{4} = 2$

$AlPO_4$, IT TURNS OUT, HAS STRUCTURES (THERE ARE SEVERAL) THAT
ARE EXACTLY THE SAME AS THOSE OF SiO_2 !!

(C) The linkage of coordination polyhedra in a structure is such that edges, and especially faces, tend not to be shared. If edges are shared they tend to be shortened.

The basis for this rule is that, regardless of coordination number, the cations inside of the polyhedra get progressively closer as the polyhedra share corners, edges and faces.

The origin of the observation in the second part of the rule is that repulsion between the cations in a chain of edge-shared polyhedra will expand, accordion-style.

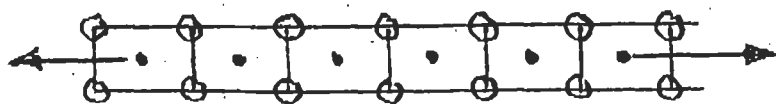

The same thing (for similar reasons) will occur for the edges of a shared face (relative to the unshared edges) for a string of face-shared polyhedra.

(D) Since sharing of polyhedral edges decreases the stability of a structure, cations with high charge and low coordination number especially do not share edges.

The origin of this observation is that (bond-distance remaining constant) the distance between the cations inside of the polyhedra rapidly decreases as their coordination number decreases.

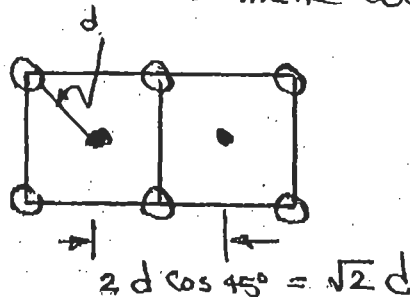
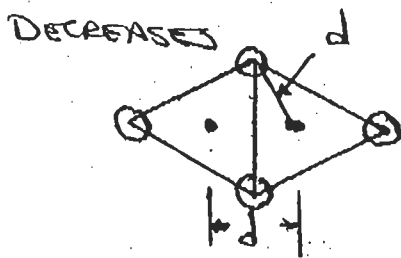

(E). The number of different kinds of atoms in a structure tends to be small.

THIS RULE — SOMETIMES REFERRED TO AS "THE LAW OF PARSIMONY" — CAN BE INTERPRETED FOR TWO MEANINGS OF "DIFFERENT": DIFFERENT STRUCTURALLY OR DIFFERENT CHEMICALLY. IN THE STRUCTURE ASSUMED BY A GIVEN COMPOUND ONE WOULD NOT EXPECT A GIVEN SPECIES TO BE PRESENT WITH MANY DIFFERENT COORDINATION NUMBERS. THE STRUCTURE WOULD NOT HAVE LOW ENERGY BECAUSE IT WOULD JUST BE TOO DIFFICULT TO FIT TOGETHER EFFICIENTLY.

THE "CHEMICAL" DIFFERENCE INTERPRETATION WOULD SUGGEST THAT, IF ONE MELTED TOGETHER IN A POT ALL OF THE ATOMS IN THE PERIODIC TABLE, ONE WOULD NOT EXPECT THEM TO CRYSTALLIZE INTO A SINGLE STRUCTURE. THE COST OF ENERGY TO DO THIS FOR IONS OF DIFFERENT SIZE, WITH DIFFERENT COORDINATION NUMBERS AS WELL, WOULD SIMPLY BE TOO GREAT. IT WOULD BE MORE EFFICIENT TO PARTITION THE CHEMICAL SPECIES INTO DIFFERENT STRUCTURES AND PAY THE PRICE, IN ENERGY, TO FOR THE INTERFACE BETWEEN THEM.

THE CONCEPT OF A "DERIVATIVE STRUCTURE"

CERTAIN MORE COMPLEX STRUCTURES CAN BE RELATED TO SIMPLER, MORE SYMMETRIC STRUCTURE BY A PERTURBATION OF ONE SORT OR ANOTHER. WE INTUITIVELY RECOGNIZE THIS IN STATEMENTS SUCH AS "THE ROCK SALT STRUCTURE OF NaCl LOOKS JUST LIKE A PRIMITIVE CUBIC ARRAY OF SPHERES EXCEPT EVERY OTHER BLACK SPHERE IS REPLACED BY A RED ONE." NaCl MAY THUS BE SAID TO BE "DERIVED" FROM A SIMPLE CUBIC ARRAY OF ATOMS.

THE CONCEPT IS USEFUL IN EXTENDING OUR UNDERSTANDING OF SIMPLE STRUCTURES TO ONES THAT ARE PROGRESSIVELY MORE COMPLICATED. IT IS MAINLY USEFUL, HOWEVER, BECAUSE IT PROVIDES A POWERFUL APPROACH TO THE DETERMINATION OF CERTAIN KINDS OF STRUCTURES FROM DIFFRACTION DATA

THERE ARE FOUR TYPES OF PERTURBATIONS THAT MAY BE EMPLOYED SEPARATELY OR IN CONCERT TO FORM A DERIVATIVE. THESE MAY BE ILLUSTRATED WITH ONE-DIMENSIONAL STRUCTURES

BASIC STRUCTURE



SUBSTITUTION DERIVATIVE



OMISSION DERIVATIVE



ADDITION DERIVATIVE ("STUFFING")



DISTORTION DERIVATIVE



Although it might seem that any structure may be regarded as a derivative of any other, the term (introduced by M.J. Buerger) is reserved for cases in which the perturbation results in suppression of symmetry operations that existed in the basic or fundamental structure have been removed. The derivative structures may be seen to have lost some of the loci in the basic structure across which the entire structure could be reflected left-to-right and remain invariant. Also, the translational periodicity of the derivatives has increased. Structures for which this is true are called superstructures. Derivative structure thus, by definition, have a lower density of symmetry operations than the parent structure.

Twelve figures of crystal structures removed for copyright reasons.

Please see: Wuensch, B. J. "The crystal chemistry of Sulfur." Chapter 16A in *Handbook of Geochemistry*. Vol. II/3. Berlin, Germany: Springer Verlag, 1972.

○ Mg²⁺

● Al³⁺

○ O²⁻

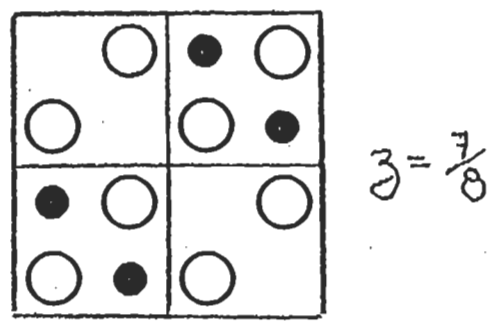
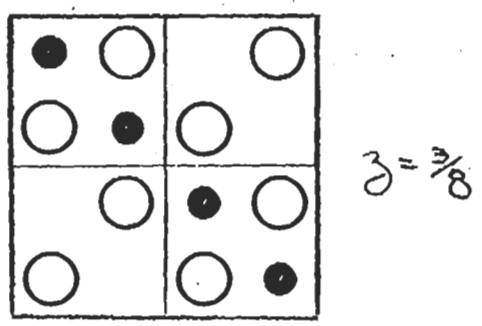
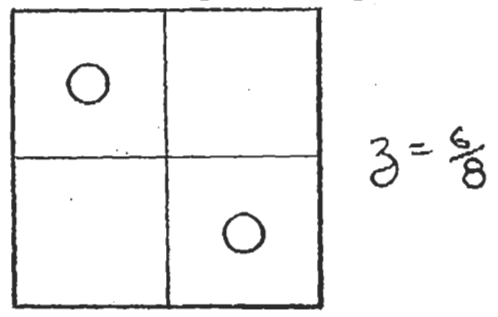
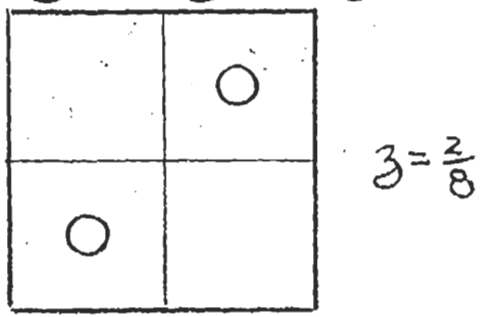
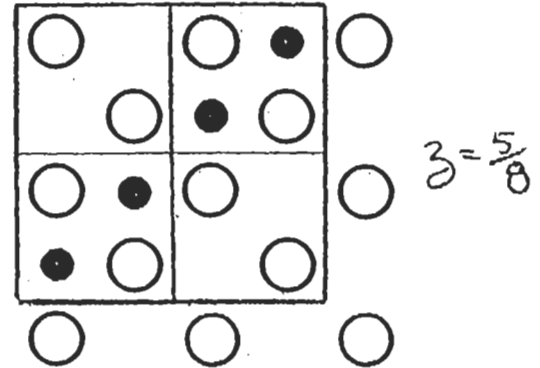
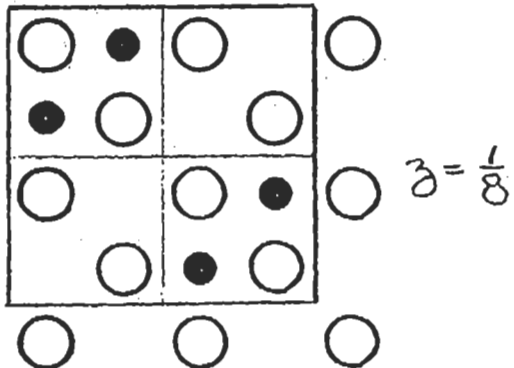
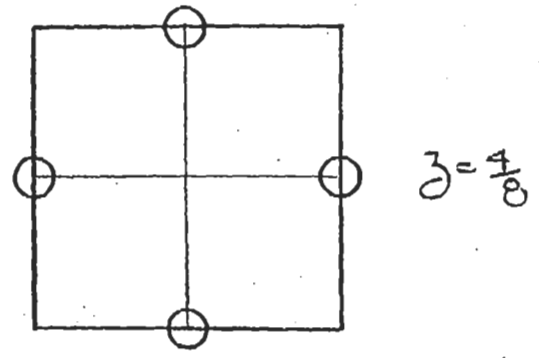
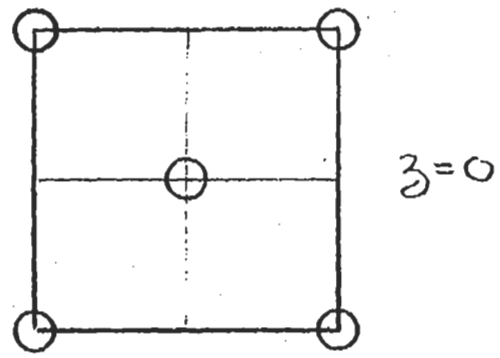

SPINEL MgAl₂O₄
 $a = 8.083 \text{ \AA}$

Fd3m - O_h⁷
 Mg²⁺ IN 8d $\bar{4}3m$ 000
 Al³⁺ IN 16d $\bar{3}m$ $\frac{1}{8}\frac{1}{8}\frac{1}{8}$
 O²⁻ IN 32e 3m xxx $x \approx \frac{3}{8}$