

Lecture 9

Fuel Cells at Finite Current

Ahmed Ghoniem

March 2, 2020

Loss mechanisms in fuel cells

Kinetics of electron transfer reactions, activation overpotential

Transport Processes and transport overpotential

Total losses and overall efficiency

Faraday's Law: $I = n_e \mathcal{S}_a \dot{n}_f$, rate of fuel utilization is $\dot{n}_f \leq (\dot{n}_f)_{\text{sup}}$

$$\eta_{FU} = \frac{\mathcal{S}}{(\dot{n}_f)_{\text{sup}} \Delta \hat{h}_{R,f}} = \frac{IV}{(\dot{n}_f)_{\text{sup}} \Delta \hat{h}_{R,f}} = \frac{I}{n_e \mathcal{S}_a (\dot{n}_f)_{\text{sup}}} \left(\frac{V}{V_{OC}} \right) \left(\frac{\zeta V_{OC}}{\Delta \hat{h}_{R,f}} \right)$$

$$= \eta_{far} \eta_{rel} \eta_{OC}$$

$$\eta_{OC} = \frac{\Delta G_R}{\Delta H_R}$$

Max power (at lower efficiency), $\sim 2.0 \text{ kW/m}^2$

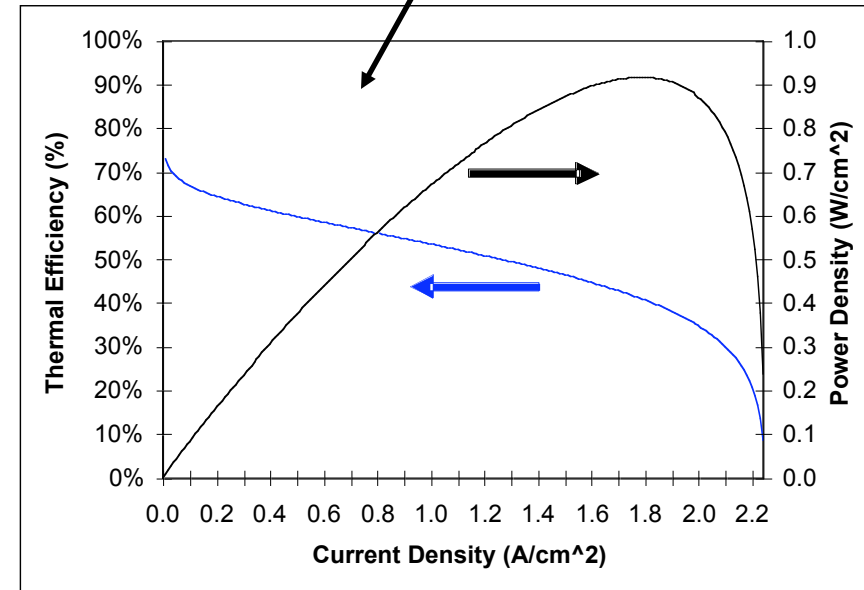
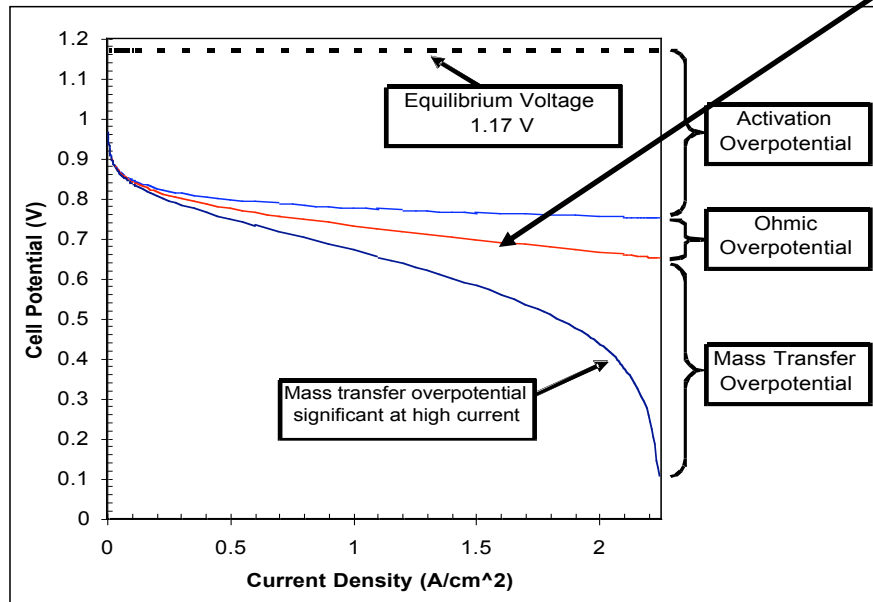

Finite-Current Performance of HTFC's

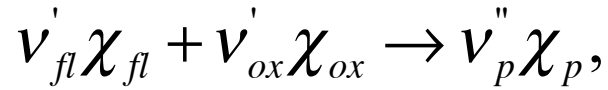

$$\Delta \mathcal{E}^{act} = \Delta \mathcal{E}^{(o)} - \frac{\sigma \mathcal{R}T^*}{n_e \mathcal{J}_a} \ln \left(\frac{p}{p_o} \right) + \frac{\mathcal{R}T}{n_e \mathcal{J}_a} \ln \left(\frac{X_{fl} X_{ox}^{v'_o}}{X_p^{v''_p}} \right)^{act}$$

must calculate concentrations where chemistry occurs

$$\Delta \mathcal{E} = \Delta \mathcal{E}^o$$

$$+ \tilde{\eta}_{a,act} + \tilde{\eta}_{a,conc} + \tilde{\eta}_{a,FU}$$

$$+ \tilde{\eta}_{el,oh}$$

$$+ \tilde{\eta}_{c,act} + \tilde{\eta}_{c,conc} + \tilde{\eta}_{a,FU}$$

$$\tilde{\eta} \equiv \text{overpotential}$$

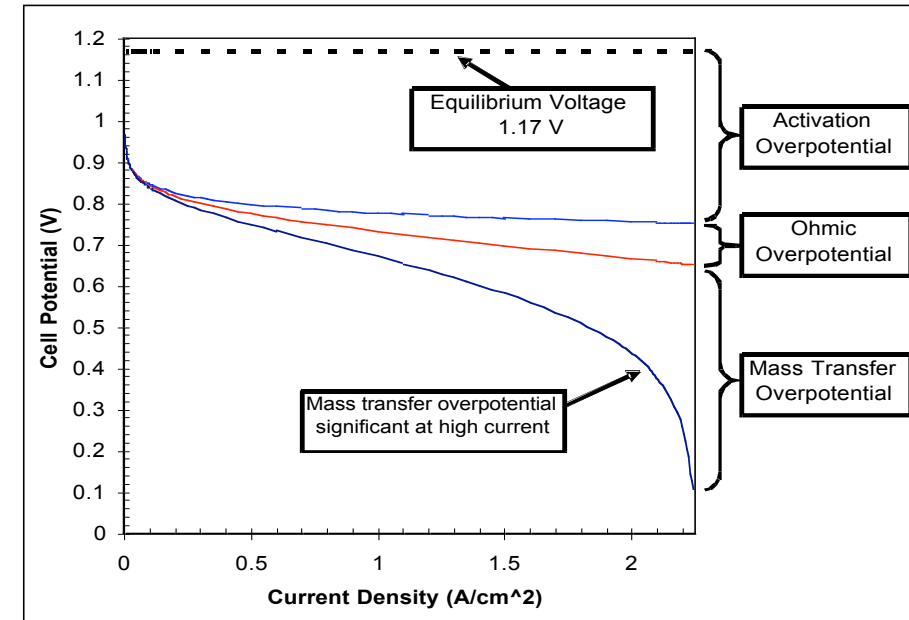

An electrochemical cell at equilibrium (left) and one producing finite current (right).

Notice the charge separation at the interface between the electrode and electrolyte (the electric double layer). The thickness of the layer is nanometer. At finite current, only the charge with higher free energy (overpotential) can overcome the potential difference across the double layer.

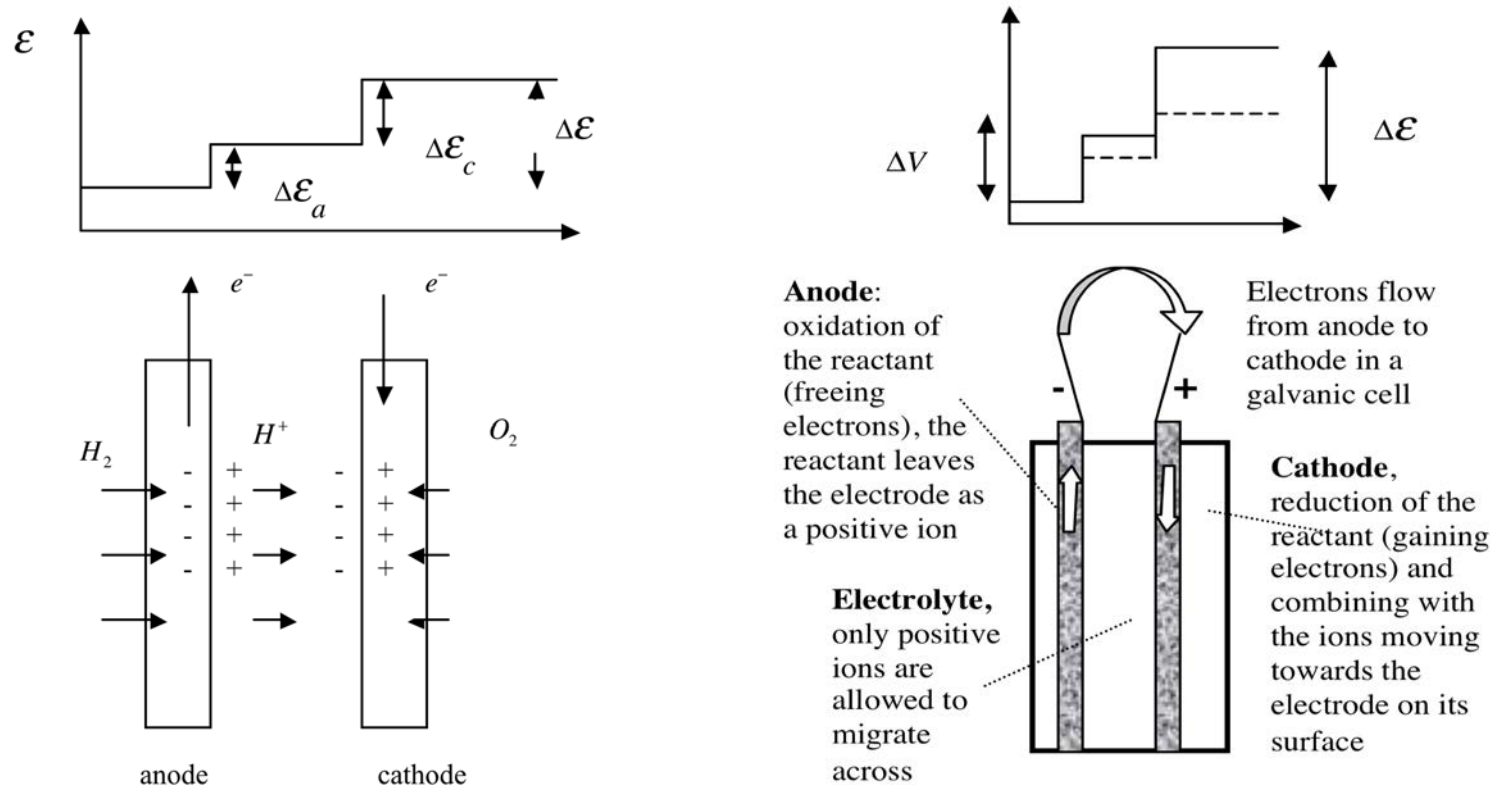

An (oversimplified) Introduction to Chemical kinetics

Rate of chemical
(thermochemical)
reaction:

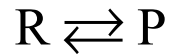

$$\frac{d[P]}{dt} = [R]k_{f0}e^{-\frac{E_f}{\mathfrak{R}T}} - [P]k_{b0}e^{-\frac{E_b}{\mathfrak{R}T}} = -\frac{d[R]}{dt} \quad (\text{Arrhenius expression})$$

E_j : the activation energy and [-] is the concentration
molecules must have excess energy to react!

Rate of
electrochemical
(charge transfer)
reaction:



$$\frac{d[P]}{dt} = [R]\tilde{k}_{f0}e^{-\frac{\mathfrak{S}_a\tilde{\eta}_f}{\mathfrak{R}T}} - [P]\tilde{k}_{b0}e^{-\frac{\mathfrak{S}_a\tilde{\eta}_b}{\mathfrak{R}T}} = -\frac{d[R]}{dt} = i$$

$\tilde{\eta}$: the activation "overpotential", or the difference between the actual
potential of the charge and the equilibrium value, that charged

species must have to jump across the layer. $\tilde{k}_{f0} = k_{f0}e^{-\frac{E_{af}}{\mathfrak{R}T}}$

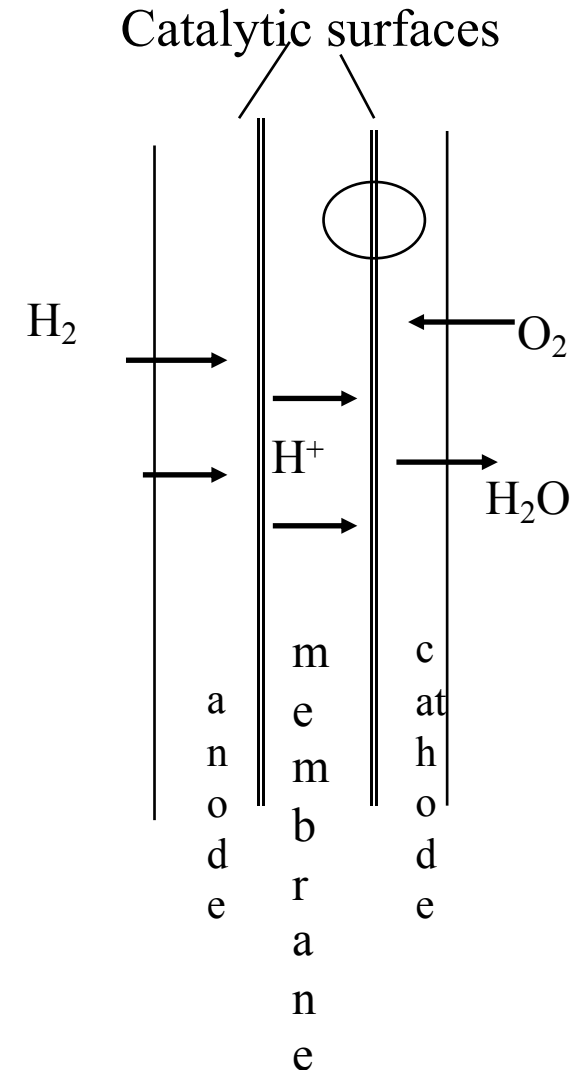

Electrochemical Reaction Kinetics

Consider the reversible oxidation reaction at an electrode: $\text{R} \xrightleftharpoons[k_b]{k_f} \text{P}^+ + \text{e}^-$

The net current = current leaving a surface

- current arriving (the reverse reaction)

$$= \mathfrak{S}_a \left(\tilde{k}_f C_R^{(s)} \exp\left(-\frac{\mathfrak{S}_a \tilde{\eta}_f}{\mathfrak{R}T}\right) \right) - n \mathfrak{S}_a \left(\tilde{k}_b C_P^{(s)} \exp\left(-\frac{\mathfrak{S}_a \tilde{\eta}_b}{\mathfrak{R}T}\right) \right)$$

The "free" energy required to drive the reaction *changes* by $\mathfrak{S}_a \tilde{\eta}$.

This energy is divided between the two layers

using a transfer coefficient, α :

$$\Delta G_{af}^\# = \Delta G_{af}^{\#0} + \alpha \mathfrak{S}_a \tilde{\eta}, \quad \text{and} \quad \Delta G_{ab}^\# = \Delta G_{ab}^{\#0} - (1 - \alpha) \mathfrak{S}_a \tilde{\eta},$$

$$\tilde{k}_f = \hat{A}_f \exp\left(-\frac{\Delta G_{af}^{\#0}}{\mathfrak{R}T}\right) \exp\left(-\alpha \frac{\mathfrak{S}_a \tilde{\eta}}{\mathfrak{R}T}\right) = k^0 \exp\left(-\alpha \frac{\mathfrak{S}_a \tilde{\eta}}{\mathfrak{R}T}\right)$$

$$\tilde{k}_b = \hat{A}_b \exp\left(-\frac{\Delta G_{ab}^{\#0}}{\mathfrak{R}T}\right) \exp\left((1 - \alpha) \frac{\mathfrak{S}_a \tilde{\eta}}{\mathfrak{R}T}\right) = k^0 \exp\left((1 - \alpha) \frac{\mathfrak{S}_a \tilde{\eta}}{\mathfrak{R}T}\right)$$

Define the exchange current density as:

$$i_0 = \frac{I_0}{A_e} = n \mathfrak{S}_a k^0 C_O^{(s)*} = n \mathfrak{S}_a \hat{A}_f \exp\left(-\Delta G_{af}^{\#0} / \mathfrak{R}T\right) C_O^{(s)*}$$

Substitute in the net current equation we get:

$$i = i_0 \left\{ \exp\left(\alpha \frac{n \mathfrak{S}_a \tilde{\eta}}{\mathfrak{R}T}\right) - \exp\left(-(1 - \alpha) \frac{n \mathfrak{S}_a \tilde{\eta}}{\mathfrak{R}T}\right) \right\},$$

$$i = i_0^* \left\{ \frac{C_O^{(s)}}{C_O^{(s)*}} \exp\left(\alpha_a \frac{n \mathfrak{S}_a \tilde{\eta}}{\mathfrak{R}T}\right) - \frac{C_P^{(s)}}{C_P^{(s)*}} \exp\left(-\alpha_c \frac{n \mathfrak{S}_a \tilde{\eta}}{\mathfrak{R}T}\right) \right\}$$

This is the Butler Volmer Equation. An implicit relation between the overpotential (loss of potential) and the current from the electrode

$$i = i_0^* \left\{ \frac{C_O^{(s)}}{C_O^{(s)*}} \exp\left(\alpha_a \frac{n\mathcal{S}_a \tilde{\eta}}{\mathcal{R}T}\right) - \frac{C_P^{(s)}}{C_P^{(s)*}} \exp\left(-\alpha_c \frac{n\mathcal{S}_a \tilde{\eta}}{\mathcal{R}T}\right) \right\}$$

exchange current density

$$\frac{I_0}{A_e} = n\mathcal{S}_a \hat{A}_f \exp\left(-\Delta G_f^{\#0} / \mathcal{R}T\right) C_O^{(s)*}$$

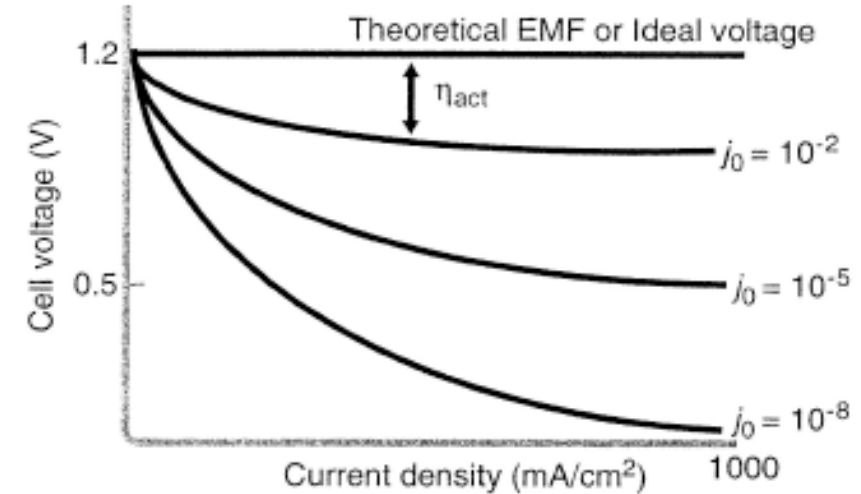

Figure 3.11. Effect of activation overvoltage on fuel cell performance. Reaction kinetics typically inflicts an exponential loss on a fuel cell's i - V curve as determined by the Butler-Volmer equation. The magnitude of this loss is influenced by the size of j_0 . (Curves calculated for various j_0 values with $\alpha = 0.5$, $n = 2$, and $T = 298.15$ K.)

© Source unknown. All rights reserved. This content is excluded from our Creative Commons license. For more information, see <https://ocw.mit.edu/fairuse>.

High exchange current density is important for reducing activation overpotential by:

1. Raising the cell temperature (see next figure) ... opposite to T 's impact on OC potential.
2. Using an active catalyst, and more of it.
3. Using a rough surface (nanostructured).
4. Increasing reactants concentrations
5. Raising the pressure.

Proton Exchange Membrane Fuel Cell (low temperature)

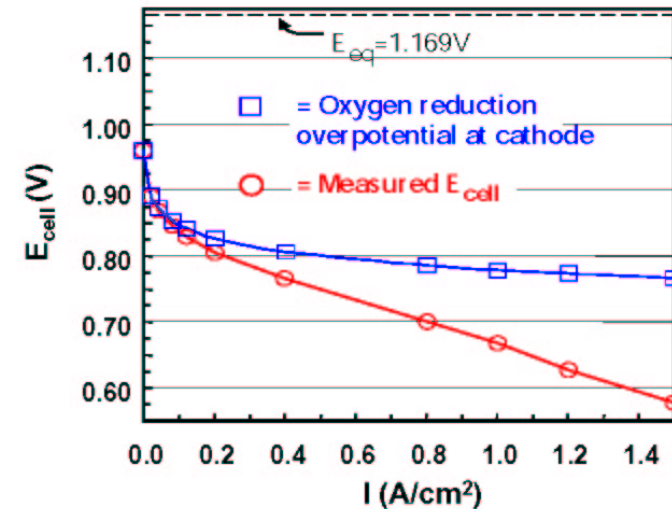
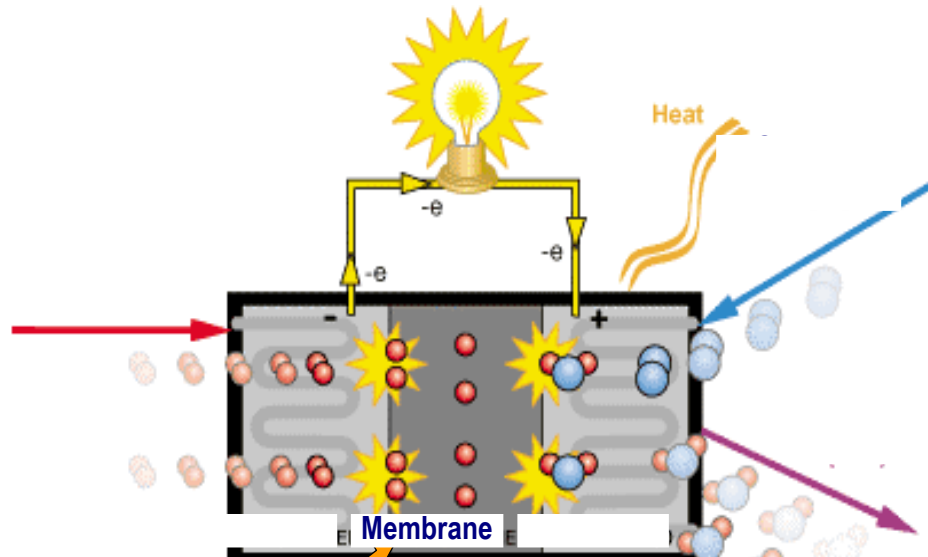
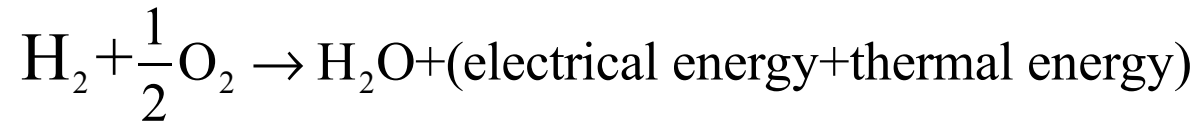

Figure 10 (Lower curve) Cell Voltage (E_{cell}) of a State-of-the-art H_2/Air Membrane Electrode Assembly Operated at 80°C versus the Current Drawn from the Cell (in amp/cm^2) (Gasteiger and Mathias 2002) (The equilibrium [theoretical] cell voltage [1.169 V] is shown by the dashed line at the top of the figure.) (Upper curve) Reduction from the Theoretical Value Caused by the Oxygen Reduction Overpotential at the Cathode Alone (Note that the overpotential is large at all but the very lowest currents. The remaining loss in potential at a given current is caused by internal resistance in the cell and to O_2 gas transport limitations through the air in the porous cathode composite.)

- Ideal for Transportation.
- Uses H_2 Only.
- Uses Platinum as a catalyst.
- Efficiency depends on power, $\sim 40\text{-}50\%$, surface power density (IV) $\sim 0.7 \text{ kW}/\text{m}^2$.

Both images © Source unknown. All rights reserved. This content is excluded from our Creative Commons license. For more information, see <https://ocw.mit.edu/fairuse>.

Effect of Cell Temperature on activation overpotential

Low T cells (left) suffer more from sluggish kinetics than high T cells (right)

for small current and overpotential: $\tilde{\eta}_{act} \approx \frac{\mathcal{R}T}{\alpha n_e \mathcal{F}} \left(\ln \frac{i + i_n}{i_o} \right)$ i_n is the "leakage" ..

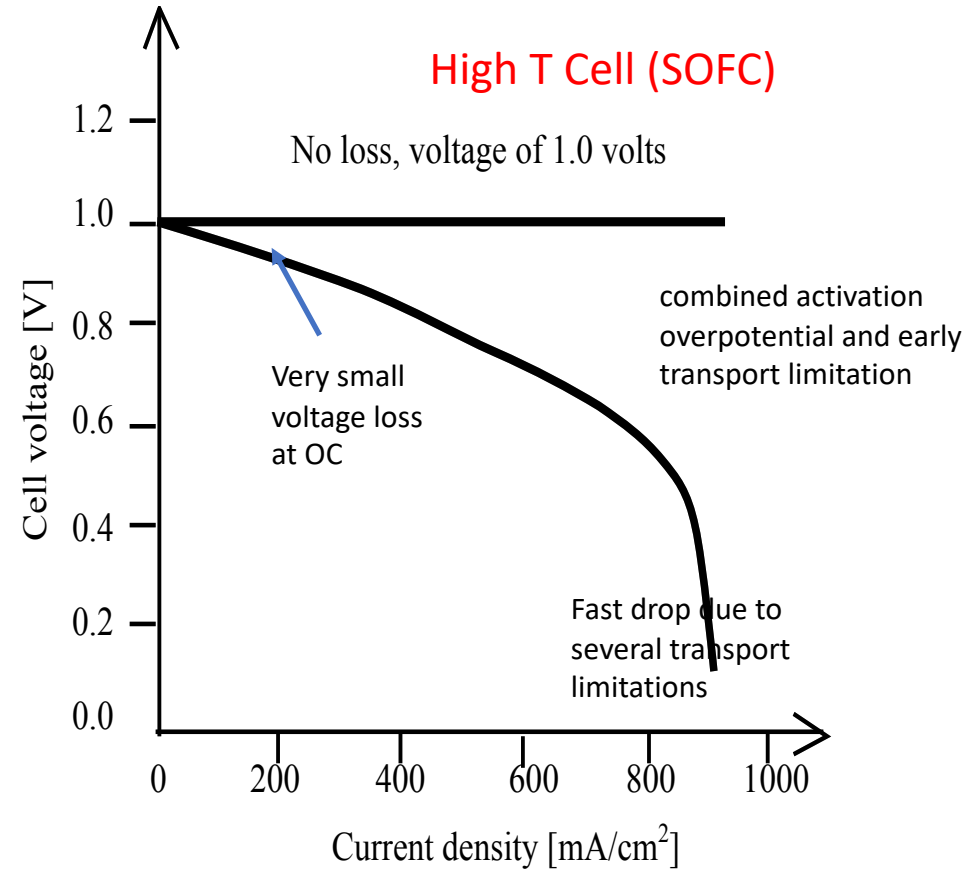
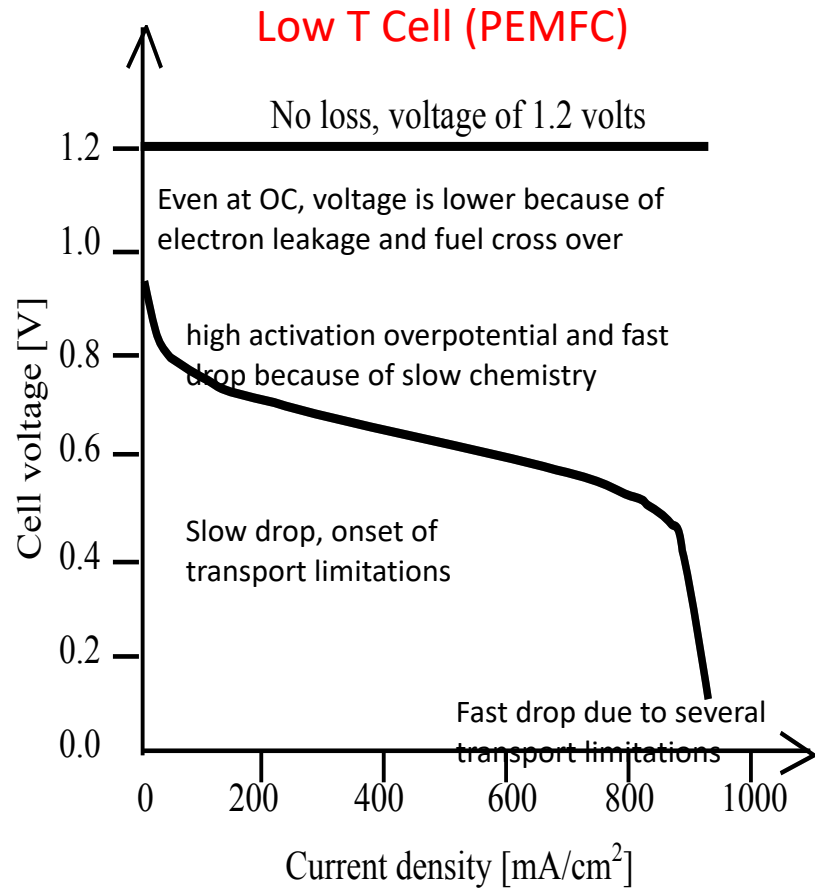

- The B-V equation applies to the anode and cathode. Should add both overpotentials to determine the total.
- Oxygen has sluggish kinetics, and higher overpotential, and dominates kinetic overpotential loss.
- Exchange current density for O_2 is $O(10^{-9} \text{ A/cm}^2)$ for Pt-acid electrolyte, vs. $O(10^{-3})$ for H_2 .
- The concentration used in the B-V equation is at *the electrode-electrolyte* interface.
- Use of air increases activation overpotential (lower oxygen concentration).

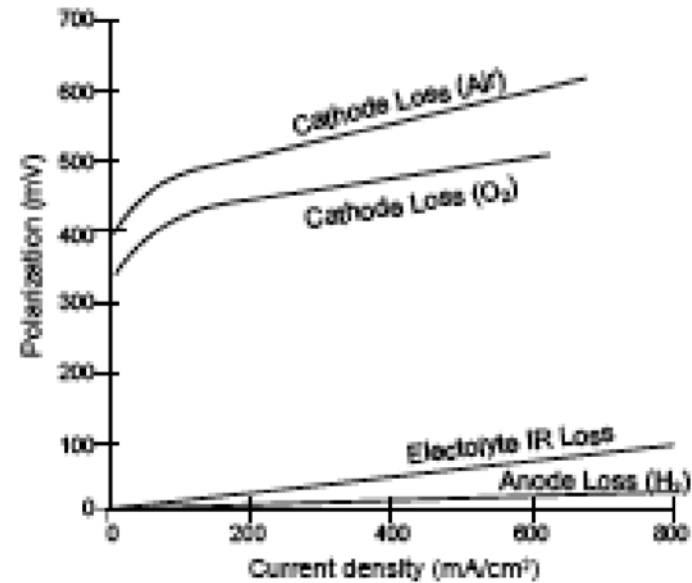

Image courtesy of DOE.

Electrochemical Cell Transport

Fick's Law of mass diffusion: $j_i = -D_i \frac{dC_i}{dx}$

Diffusion is associated with the presence of a species gradient!

very similar to heat diffusion (conduction) where $q = -\lambda \frac{dT}{dx}$

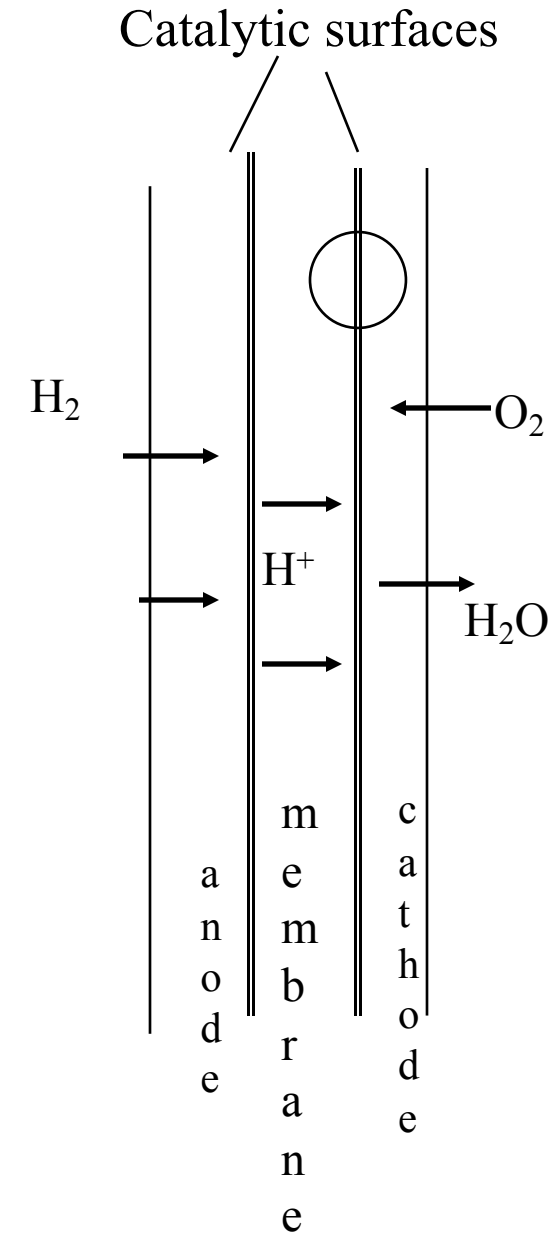
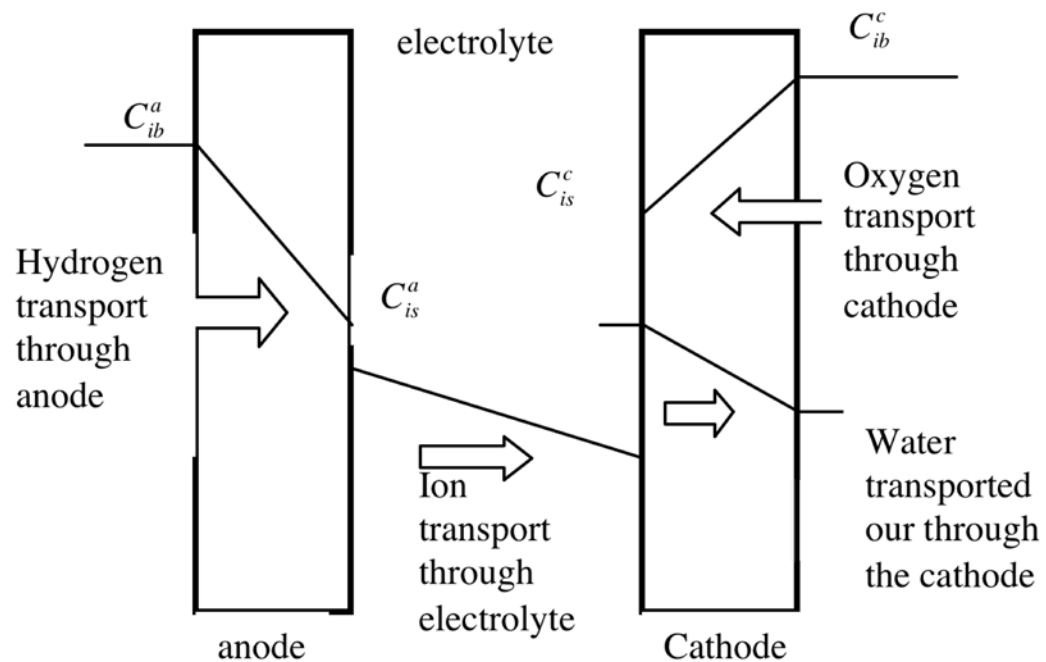

Overpotentials occur due to concentration drop across several layers,

$$\Delta \mathcal{E}(T, p_i) = \Delta \mathcal{E}^o(T) + \frac{\mathcal{R}T}{2\mathcal{F}_a} \left(\frac{1}{2} \ln p \right) + \frac{\mathcal{R}T}{2\mathcal{F}} \left(\ln X_{H_2} + \frac{1}{2} \ln X_{O_2} - \ln X_{H_2O} \right)$$

Concentrations should be evaluated at the reactive surfaces of the electrodes,

The drop of concentrations is due to transport.

The difference in concentrations across each layer creates an overpotential.

Take one concentration: based on concentrations at interface: $\Delta \mathcal{E}_{act} = \Delta \bar{\mathcal{E}}^o + \frac{\mathcal{R}T}{n_e \mathcal{F}_a} \ln C_i^{(act)}$,

But based on concentration in the supply channel: $\Delta \mathcal{E}_{sup} = \bar{\mathcal{E}}^o + \frac{\mathcal{R}T}{n_e \mathcal{F}_a} \ln C_i^{(sup)}$

difference is concentration overpotential: $\tilde{\eta}_{conc} = \Delta \mathcal{E}_{act} - \Delta \mathcal{E}_{sup} = \frac{\mathcal{R}T}{n_e \mathcal{F}_a} \ln \frac{C_i^{(act)}}{C_i^{(sup)}}$

or: $\Delta \mathcal{E}_{act} = \Delta \mathcal{E}_{sup} + \tilde{\eta}_{conc}$

Transport Overpotentials across an electrode in terms of limiting current density

$$\tilde{\eta}_{conc} = \frac{\mathcal{R}T}{n_e \mathcal{S}_a} \left(\ln \frac{C_{is}}{C_{ib}} \right) \quad \{ C_{is} < C_{ib} \}$$

Fick's law of diffusion: $j_i = -D_i \frac{dC_i}{dx},$

and $C_{ib} - C_{is} = \frac{\delta_{electrode}}{D_{electrode}} j_i$

At limiting conditions $C_{is} = 0$: $C_{ib} = \frac{\delta_{electrode}}{D_{i,electrode}} j_{i,lim}$

this is limiting current: $i_{lim} = n_e \mathcal{S}_a j_{i,lim} = n_e \mathcal{S}_a \frac{D_{electrode}}{\delta_{electrode}} C_{ib}$

Thus the concentration ratio for any current is $\frac{C_{is}}{C_{ib}} = 1 - \frac{i}{i_{lim}}$

the electrode diffusion overpotential: $\tilde{\eta}_{el,conc} = \frac{\mathcal{R}T}{n_e \mathcal{S}_a} \ln \left(1 - \frac{i}{i_{lim}} \right)$

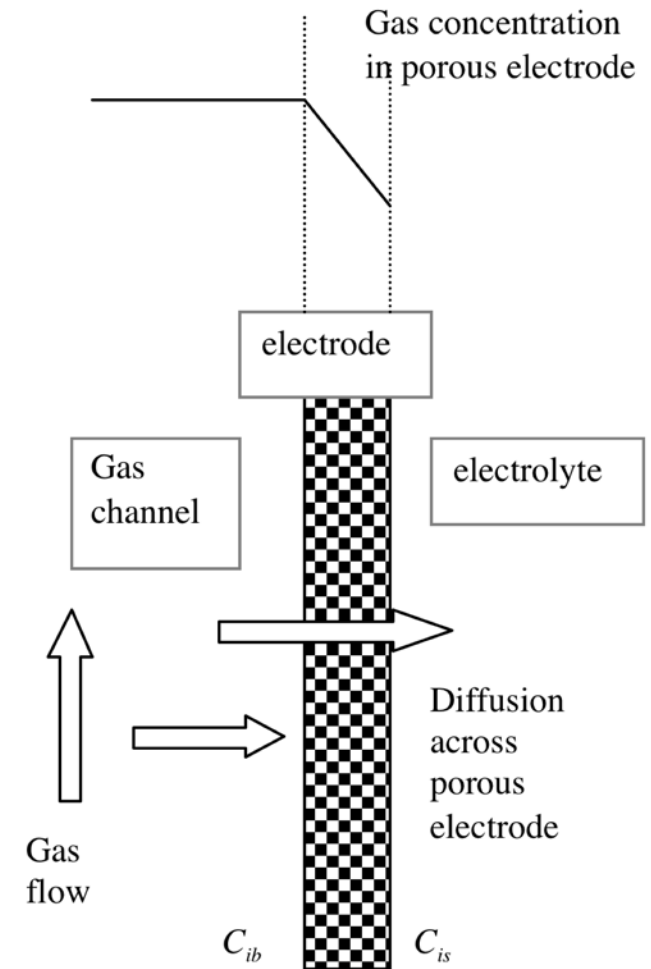

$$i_{\text{lim}} = n_e \mathfrak{S}_a D_i \frac{C_{ib}}{\delta_e}$$

Most cell designs have $i_{\text{lim}} = O(1 \text{ A/cm}^2)$. Why:

- $n_e = 1 - 2$,
- $\mathfrak{S}_a = 98,487 \text{ Coulombs/mol}$,
- $D_i \sim 10^{-5} - 10^{-6} \text{ m}^2/\text{s}$,
- $C_{ib} \sim 10 \text{ mol/m}^3$ (for oxygen in air at SAP),
- $\delta_e = 10^{-4} \text{ m}$.

The limiting current density can be raised by:

- Increasing the effective diffusivity of the reactants through the electrodes;
- Increasing the reactants concentrations in the supply channels; and,
- Decreasing the thickness of the electrodes.

Expression must be corrected for concentration drop
across the boundary layer in the gas channel
(in case a carrier gas is used)

$$j_i = h_{conc} (C_{i\infty} - C_{ib}) = -D_{el} \frac{C_{i\infty} - C_{ib}}{\delta_{electrode}}$$

Sherwood number for mass transfer: $Sh = \frac{h_{conc} d_h}{D_{gas}} = O(3-5)$

Eliminate C_{ib} and use Faraday's law:

$$i = n_e \mathcal{S}_a j_i = n_e \mathcal{S}_a \frac{C_{i\infty} - C_{is}}{\left(\frac{\delta_{el}}{D_{el}} + \frac{1}{h_{conv}} \right)}$$

$$i_{lim} = n_e \mathcal{S}_a \frac{C_{i\infty}}{\left(\frac{\delta_{el}}{D_{el}} + \frac{1}{h_{conv}} \right)}$$

the total electrode transport overpotential: $\tilde{\eta}_{el,transpot} = \frac{\mathcal{R}T}{n_e \mathcal{S}_a} \ln \left(1 - \frac{i}{i_{lim}} \right)$

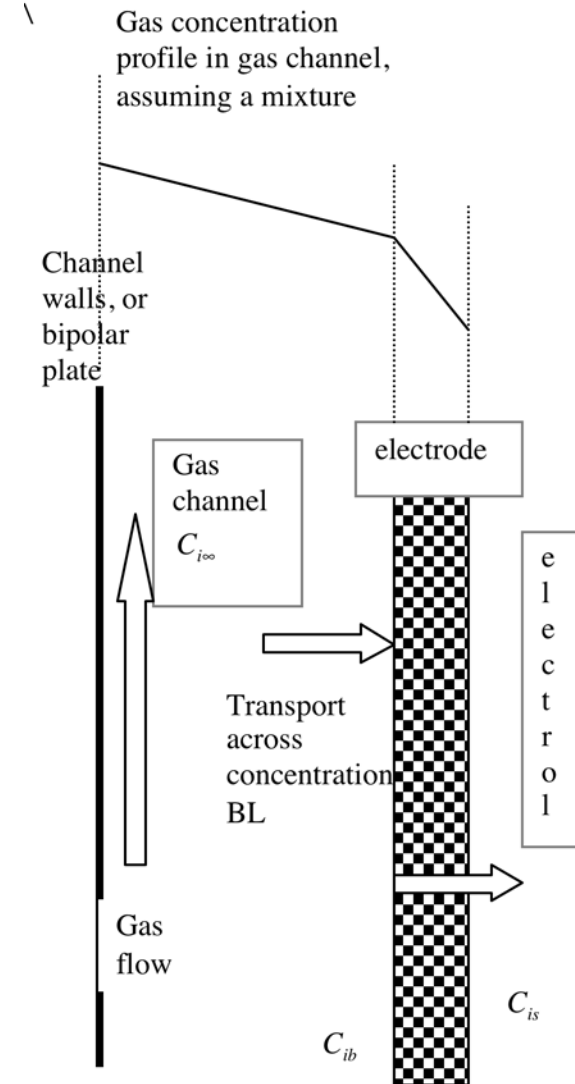

Recall that the kinetic overpotential depends on the concentration

at the electrode surface, hence:
$$\tilde{\eta}_{el,conc,tot} = \frac{\mathfrak{R}T}{n_e \mathfrak{S}} \left(1 + \frac{1}{\alpha} \right) \ln \left(1 - \frac{i}{i_{lim}} \right)$$

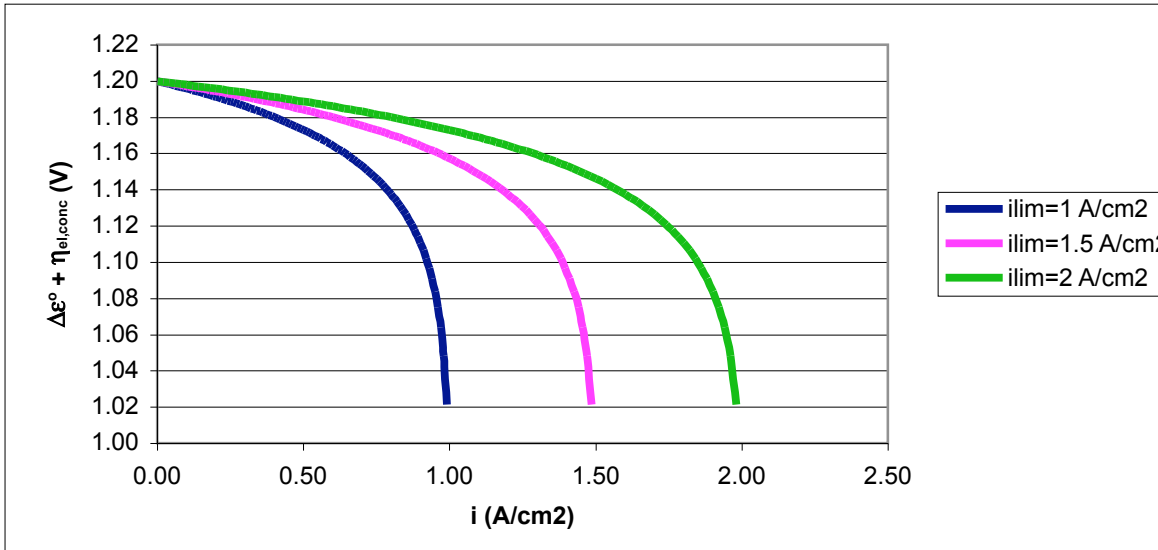

In a porous electrode:
$$D_{ij}^{eff} \approx D_{ij} \frac{\epsilon}{\tau}$$

ϵ : porosity = $\frac{\text{pore volume}}{\text{total volume}}$

τ : tortuosity = $\frac{\text{pore length}}{\text{thickness}}$

Ohmic Overpotential:

Voltage drop due to resistance to charged species flow

Within electrolyte, resistance to ion flow

Within electrodes, resistance to electron flow:

$$\tilde{\eta}_{oh} = - (R_{electrodes} + R_{electrolyte}) I$$

and $I = i A_{electrolyte}$

$$R_{electrolyte} = \frac{t_{electrolyte}}{A_{electrolyte} \sigma_{electrolyte}},$$

where the conductivity is: $\sigma = |z_i| \mathfrak{S}_a C_i \tilde{u}_i$

and the charge mobility is

$$\tilde{u}_i = \frac{|z_i| \mathfrak{S}_a D_i}{\mathfrak{R}T} \text{ and } D_i \text{ the Diffusivity.}$$

Diffusivity depends on electrolyte material, water content (in polymer electrolytes), temperature and concentration.

Finite-Current Performance of HTFC's

Fuel cells suffer significant irreversibility due to finite-rate processes.

$$\begin{aligned} \Delta \mathcal{E} = & \Delta \mathcal{E}^o \\ & + \tilde{\eta}_{a,act} + \tilde{\eta}_{a,conc} + \tilde{\eta}_{a,FU} \\ & + \tilde{\eta}_{el,oh} \\ & + \tilde{\eta}_{c,act} + \tilde{\eta}_{c,conc} + \tilde{\eta}_{a,FU} \end{aligned}$$

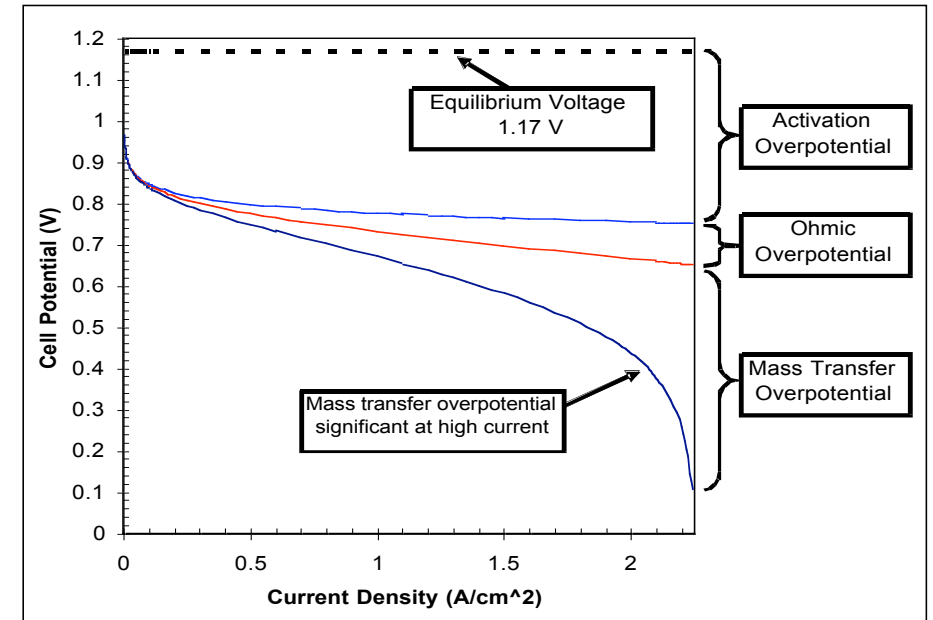

$$\eta = \frac{\text{Power Out}}{\text{Rate of Chemical Enthalpy}} = \frac{I \cdot V}{\dot{n}_f \Delta H_R^o} = \eta_{OC} \cdot \underbrace{\frac{\eta_{rel}}{V}}_{V_{OC}} \cdot \underbrace{\frac{\eta_{Far}}{I}}_{n_e \mathcal{I} \dot{n}_{fuel}}$$

Finite-Current Performance of SOFC'

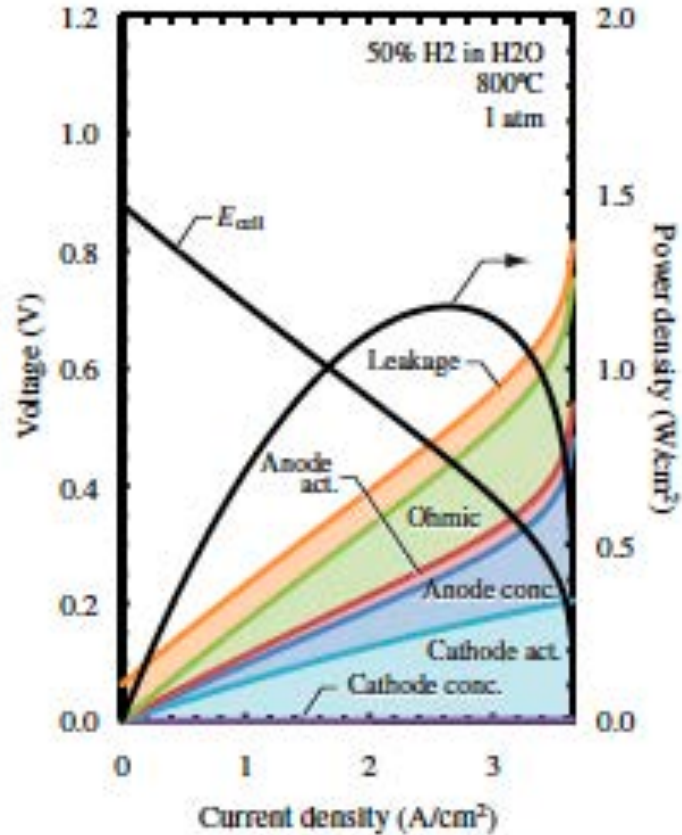

Different voltage losses in a typical SOFC running on hydrogen, losses are shown cumulatively starting with cathodic concentration overpotential, cathodic activation overpotential, etc. (Hanna, Shi and Ghoniem, PECS, 40 (2014))

© PECS. All rights reserved. This content is excluded from our Creative Commons license. For more information, see <https://ocw.mit.edu/fairuse>.

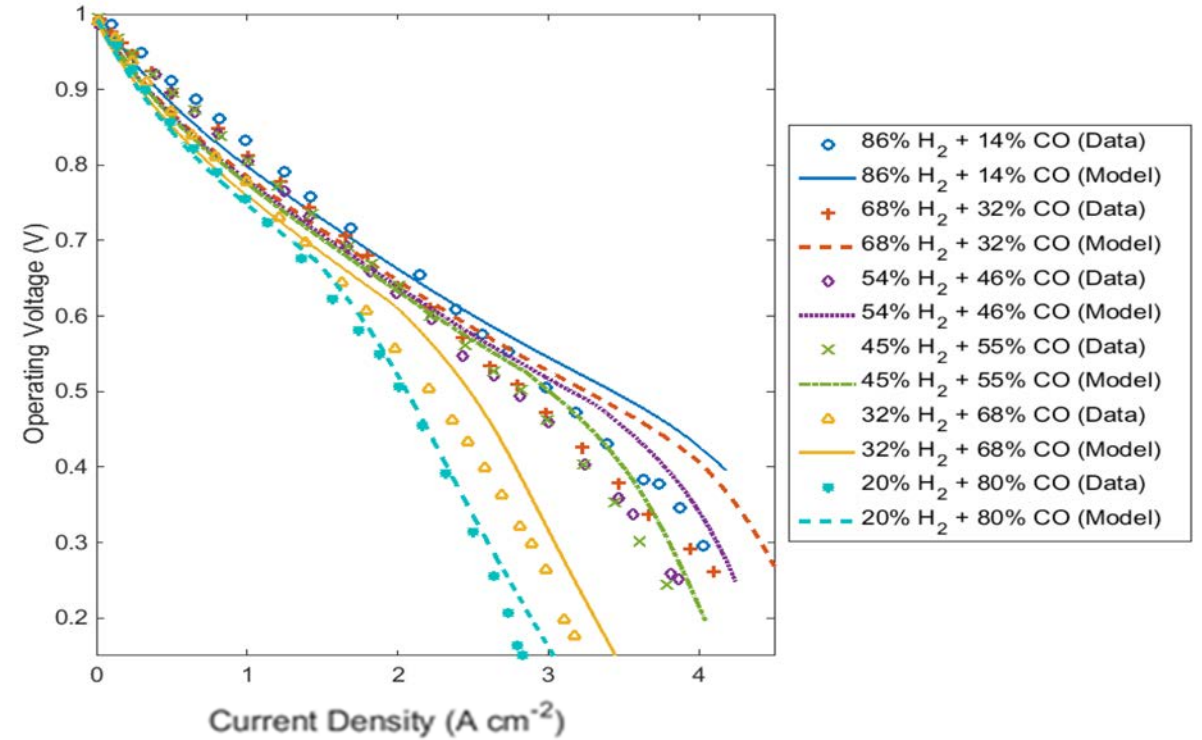

Polarization curve for an SOFC running on syngas with different concentration of H₂ to CO. CO electrochemistry is more sluggish and hence the fast drop. Ong and Ghoniem, IJHE, 41(2016)

© UHE. All rights reserved. This content is excluded from our Creative Commons license. For more information, see <https://ocw.mit.edu/fairuse>.

Electrochemical Cell Kinetics

One electrochemical (electron transfer) reaction on each side

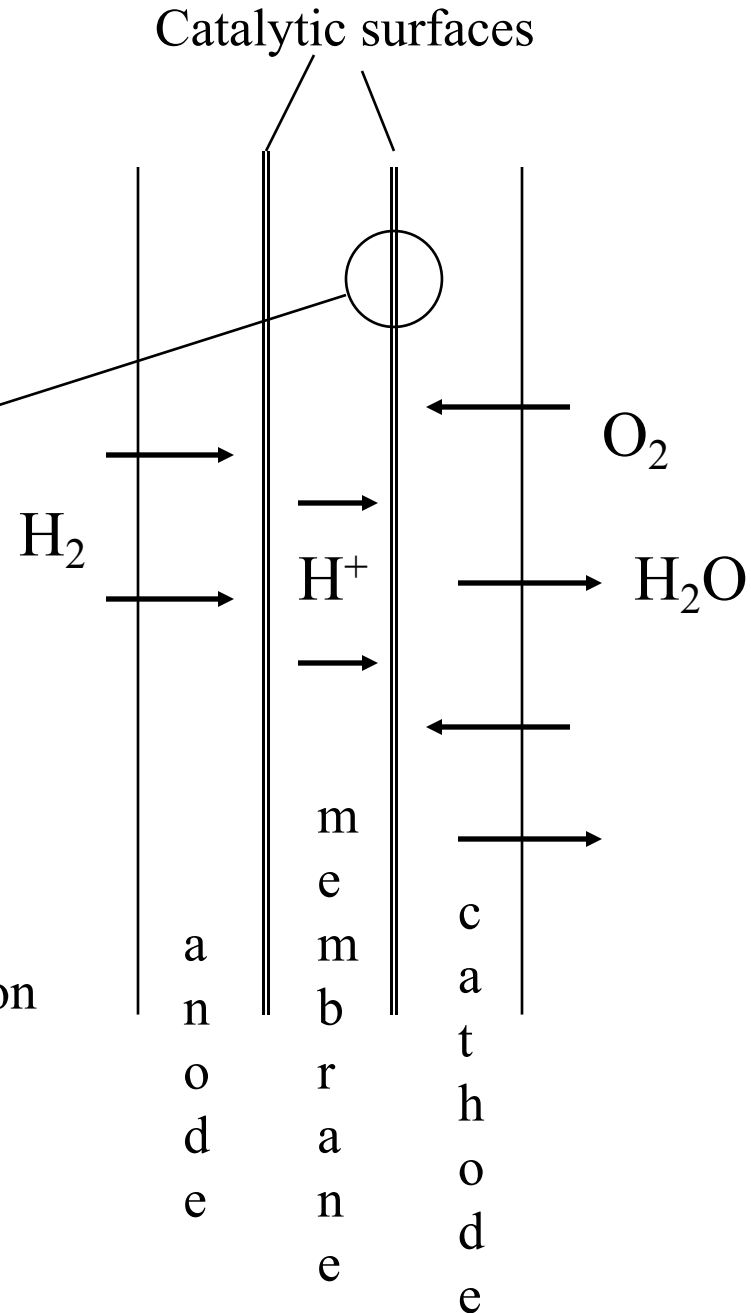
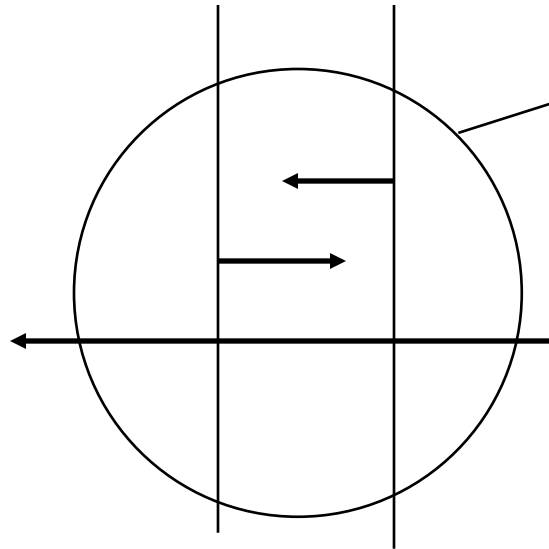

Overall cathodic (charge transfer) reaction

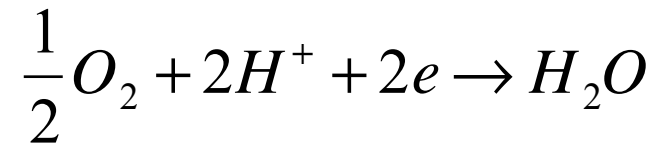

Electrochemical Reaction Kinetics

- The electrochemical reaction on each electrode separates the charge, forming an electric double layer.
- The chemical free energy of the reaction is stored in the electric field.

At Equilibrium, on the electrode surface,

- the chemical free energy and the electrical energy are equal.
- the charge concentrations are equal at the surface and outer plane.
- the net current out of the surface is zero.

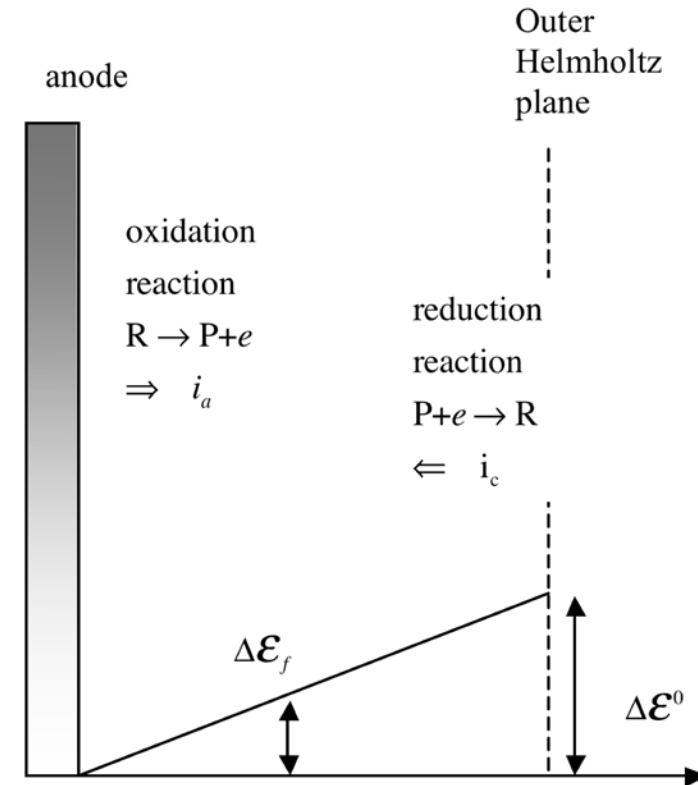

The free energy associated with the forward reaction equals the work done to separate the charge

Electrochemical Reaction Kinetics

consider the oxidation reaction:
$$\text{R} \underset{k_b}{\overset{k_f}{\rightleftharpoons}} \text{P} + e$$

the current leaving a surface is
$$i_a = \mathfrak{S}_a \left(k_f C_R^{(s)} \right)$$

on the outer plan, the reverse reaction occurs;
$$i_c = \mathfrak{S}_a \left(k_b C_p^{(s)} \right)$$

the net current is the balance of the two reactions;
$$i = i_a - i_c$$

The reaction rate constant depends on the free energy available to drive the reaction

$$k_{f/b} = \hat{A}_{f/b} \exp\left(-\frac{\Delta G_{f/b}^\#}{\mathfrak{R}T}\right)$$

In electrochemistry, we should use total available Gibbs free energy

$$\Delta \hat{G}^\# = \Delta \hat{G} + n_e \mathfrak{S}_a \Delta \mathcal{E} \quad \text{where } \Delta \mathcal{E} \text{ is the local electric potential.}$$

the second term is energy consumed in moving the charge through the potential.

Under finite current, nonequilibrium conditions, the net current

between the two layers is associated with a potential $\tilde{\eta}$, the "overpotential"
And the "free" energy available to drive the reaction changes by $\mathfrak{S}_a \tilde{\eta}$.

The change of energy is divided between the two layers
according to the transfer coefficient, α , $0 \leq \alpha \leq 1$:

$$\Delta G_{af}^{\#} = \Delta G_{af}^{\#0} + \alpha \mathfrak{S}_a \tilde{\eta},$$

$$\Delta G_{ab}^{\#} = \Delta G_{ab}^{\#0} - (1 - \alpha) \mathfrak{S}_a \tilde{\eta},$$

$$k_f = \hat{A}_f \exp\left(-\frac{\Delta G_{af}^{\#0}}{\mathfrak{R}T}\right) \exp\left(-\alpha \frac{\mathfrak{S}_a \tilde{\eta}}{\mathfrak{R}T}\right) = k^0 \exp\left(-\alpha \frac{\mathfrak{S}_a \tilde{\eta}}{\mathfrak{R}T}\right)$$

$$k_b = \hat{A}_b \exp\left(-\frac{\Delta G_{ab}^{\#0}}{\mathfrak{R}T}\right) \exp\left((1 - \alpha) \frac{\mathfrak{S}_a \tilde{\eta}}{\mathfrak{R}T}\right) = k^0 \exp\left((1 - \alpha) \frac{\mathfrak{S}_a \tilde{\eta}}{\mathfrak{R}T}\right)$$

MIT OpenCourseWare
<https://ocw.mit.edu/>

2.60J Fundamentals of Advanced Energy Conversion
Spring 2020

For information about citing these materials or our Terms of Use, visit: <https://ocw.mit.edu/terms>.